

Cleaning technology · Municipal technology

**Hako**  
Clean ahead



## **Scrubmaster B260 R (7182)**

### **Operating manual**

Part number 88-10-3142 - 4070-43

Valid as from: 08.2019

## Introduction

### Foreword

Dear Customer,

We are certain that the excellent qualities of the machine will justify the faith you have shown in us by your purchase.

To guarantee safe working with the machine, please read the Safety Notes chapter before putting it into service.

Your own safety, as well as the safety of others, depends essentially on your ability to control the vehicle. Please read this **original operating manual** before you use the vehicle for the first time, act accordingly and keep these instructions for future reference or subsequent users. The operating manual contains all important information for operation, maintenance and care. We have provided the places in this operating manual concerning your safety with a danger pictogram. Your authorised Hako dealer is available at all times to answer further questions about the vehicle or the operating manual.

We would expressly advise you that no legal claims may be asserted based on the contents of this operating manual. In the case of necessary repair work, please make sure that only original spare parts are used. Spare parts must be original spare parts to guarantee safety. We reserve the right to make changes in the interests of further technical development.

### Hako GmbH

23843 Bad Oldesloe, Germany

Hamburger Str. 209-239

Phone +49 4531 806-0

### Issue:

Index	Book number	Change no.	Valid as from:
0	88-10-3142	4070-43	08.2019

**Intended use**

Scrubmaster B260 R is a scrubber-drier for the wet cleaning of hard indoor floor surfaces. This machine is intended for commercial use, e.g. in shopping centres, swimming pools, shops, airports, schools and hotels. The Scrubmaster B260 R with X-AC drive is additionally intended for use in multi-storey car parks. Any use extending beyond this is not intended use. The manufacturer is not liable for any damage resulting from this and the user alone bears the risk. Intended use also includes compliance with the operating, maintenance and servicing conditions specified by the manufacturer.

The Scrubmaster B260 R may be used, maintained and repaired only by persons who are familiar with this work and instructed about the dangers. The relevant accident prevention regulations as well as the other generally recognised safety engineering and occupational medical rules must be complied with.

The machine corresponds by virtue of its design and construction as well as in the version distributed by us to the usual health and safety requirements of the EC Directives (see Declaration of Conformity). This declaration loses its validity in the event of a modification to the machine not authorised by us. The manufacturer is not deemed liable for any damage resulting from unauthorised modifications to the machine.

**Notes on warranty**

The terms defined in the purchase agreement apply. Claims for compensation in relation to damage are excluded from the terms of the warranty when the damage is the result of the failure to observe rules concerning servicing and maintenance. Maintenance work must be carried out by an authorised Hako service workshop and confirmed in the "Maintenance Report", which serves as a warranty logbook.

The following are excluded from the terms of warranty: wear and tear through overuse, defective fuses, improper handling and use and unauthorised modifications. Claims under the terms of the warranty are also annulled when damage occurs to the machine resulting from the use of parts or accessories not explicitly approved of by us or from failure to observe maintenance rules.

**Acceptance of the machine**

Inspect the machine immediately on delivery for signs of transport damage. You will be compensated for transport damage provided you immediately have the damage confirmed by the transport company and send in the damage report together with the consignment note to us.

**Machine data**

Your machine is described clearly by the following data. Please always quote these data in correspondence or when making a telephone query to your authorised Hako dealer or our company.

- Machine type \_\_\_\_\_
- Manufacturing no. \_\_\_\_\_
- Start-up on: \_\_\_\_\_

**Your nearest authorised Hako dealer:**

- Address \_\_\_\_\_  
\_\_\_\_\_  
\_\_\_\_\_
- Telephone \_\_\_\_\_

	<b>Introduction.....</b>	<b>2</b>
	Foreword .....	2
	Intended use .....	3
	Notes on warranty .....	3
	Acceptance of the machine .....	4
	Machine data .....	4
<b>1</b>	<b>Safety instructions .....</b>	<b>8</b>
1.1	Warning and danger symbols .....	8
1.2	General safety instructions .....	9
1.3	Operating safety instructions .....	10
1.3.1	Before putting into service .....	10
1.3.2	During operation .....	10
1.3.3	After operation .....	11
1.4	Maintenance instructions .....	12
1.5	Information about special risks .....	13
1.5.1	Electrical system .....	13
1.5.2	Batteries .....	13
1.6	Environmental protection instructions and disposal .....	15
1.7	Labels on the machine .....	16
1.8	Labels on the pre-sweep suction unit .....	19
<b>2</b>	<b>Operation.....</b>	<b>20</b>
2.1	Overviews .....	20
2.1.1	Front view .....	21
2.1.2	Rear view .....	23
2.1.3	Control panel .....	24
2.2	Controls and display elements .....	26
2.2.1	Control panel .....	26
2.3	Multifunction display .....	31
2.3.1	Menu guidance .....	31
2.3.2	Main menu .....	32
2.3.3	Sub-menu .....	38
2.3.4	Controls at the machine .....	42
2.4	Functional description .....	44
2.4.1	Solution tank .....	44
2.4.2	Rotating brush and roller brush unit .....	45
2.4.3	Side brush unit .....	45
2.4.4	Wiper .....	45
2.4.5	Squeegee .....	46
2.4.6	Waste water tank .....	46
2.4.7	Suction turbines .....	46
2.4.8	Travel drive .....	47
2.4.9	Brakes .....	47
2.4.10	Batteries .....	47

<b>3</b>	<b>Operation.....</b>	<b>48</b>
3.1	Instruction .....	48
3.2	Before putting into service .....	48
3.3	Check list: Before machine start-up .....	48
3.3.1	Driver's seat .....	49
3.3.2	Side mirror (optional) adjustment .....	50
3.4	Cleaning .....	51
3.4.1	Entry.X (optional) .....	52
3.4.2	On-board dosing system (option) .....	53
3.4.3	Useful cleaning tips .....	55
3.4.4	Handling and braking the vehicle .....	56
3.4.5	Pushing the machine .....	57
3.4.6	Turning off the machine .....	58
3.4.7	Check list: After cleaning .....	58
3.5	Loading and transporting .....	59
3.6	Service information .....	60
<b>4</b>	<b>Technical data.....</b>	<b>62</b>
<b>5</b>	<b>Maintenance and Servicing .....</b>	<b>66</b>
5.1	Maintenance plan .....	67
5.2	Battery .....	68
5.2.1	Checking the charging state .....	68
5.2.2	Charge the battery .....	69
5.2.3	Checking the acid level .....	71
5.2.4	Replacing the battery .....	72
5.2.5	Battery plug coding .....	73
5.2.6	Maintaining drive batteries .....	74
5.2.7	Taking the machine out of service for a long period .....	74
5.2.8	Disposing of batteries .....	74
5.3	Solution tank .....	75
5.3.1	Filling the solution tank .....	75
5.3.2	Emptying the solution tank .....	77
5.3.3	Cleaning the solution tank .....	77
5.4	Waste water tank .....	78
5.4.1	Emptying the waste water tank .....	78
5.4.2	Cleaning the waste water tank .....	79
5.4.3	Cleaning the coarse dirt sieve .....	80
5.4.4	Cleaning the intake sieve .....	80
5.4.5	Checking the seal at the drain valve .....	80
5.4.6	Cleaning the fresh water filter .....	81
5.4.7	Checking the seal in the tank cap .....	81
5.5	Rotating brush unit .....	82
5.5.1	Replacing the brushes/pads .....	82
5.5.2	Cleaning the brushes .....	82

5.5.3	Ejecting the brushes/pads .....	83
5.5.4	Coupling the brushes/pads .....	83
5.6	Side brush unit (optional) .....	84
5.6.1	Adjusting the side brush .....	84
5.6.2	Changing the side brush .....	85
5.7	Squeegee .....	86
5.7.1	Cleaning the squeegee .....	86
5.7.2	Changing the sealing/slot strip .....	88
5.7.3	Adjusting the sealing strips .....	89
5.8	Wiper .....	91
5.8.1	Changing the wiper rubber .....	91
5.9	Pre-sweep suction unit (optional) .....	92
5.9.1	Emptying the dirt hopper .....	92
5.9.2	Dirt hopper seal .....	92
5.9.3	Shaking the filter .....	93
5.9.4	Cleaning the filter .....	93
5.9.5	Cleaning the cylindrical brush and the cylindrical brush compartment .....	94
5.9.6	Changing the cylindrical brush .....	94
5.9.7	Adjusting the sweeping level .....	95
5.9.8	Replacing the sealing strips of the cylindrical brush compartment .....	95
5.9.9	Changing the side brush .....	96
5.9.10	Adjusting the sweeping level .....	96
<b>6</b>	<b>Attachments/options .....</b>	<b>97</b>
6.1	Spray suction tool .....	97
6.2	Manual suction tool .....	98
6.3	Spray nozzle .....	99
6.4	Pre-sweep suction unit .....	100
6.4.1	Pre-sweep suction unit installation .....	100
6.4.2	Check and correct settings .....	101
6.4.3	Sweeping operation .....	102
6.4.4	Stop sweeping operation .....	102
6.4.5	After sweeping .....	102
6.4.6	Parking the pre-sweep suction unit .....	103
6.5	Overhead guard .....	103
6.6	Blue Spot .....	104
	<b>EC Declaration of Conformity .....</b>	<b>105</b>

# 1 Safety instructions

## 1.1 Warning and danger symbols

Important tasks concerning the safety of the operator and machine are named as follows in this operating manual and emphasised by symbols.



### **Danger**

Indication of a direct danger with high risk, in which death or severe physical injury can occur if it is not avoided.



### **Warning**

Indication of a possible danger with average risk, in which death or severe physical injury can occur if it is not avoided.



### **Caution**

Indication of a danger with low risk, in which light to medium severe physical injury or material damage can occur if it is not avoided.



### **Attention**

Attention indicates a hazard that can lead to technical damage when not observed.



### **Environmental danger**

Environmental danger due to the use of substances from which a health and environmental risk proceeds.



### **Note**

Indication of information that facilitates more effective and economical use of the machine.



**Note**

Before starting up the machine, read the following safety instructions and act accordingly. Machine operating errors can be avoided and trouble-free operation can be guaranteed only with precise factual knowledge.

## 1.2 General safety instructions

- Apart from the instructions in this operating manual, the general safety and accident prevention regulations of the legislation must be taken into account.
- Before the machine is put into service, please carefully read the operating manual you receive as well as further separate instructions for additional implements or attachments and observe them in all aspects of your work.
- The machine may be used, maintained and repaired only by persons who have been instructed by Hako experts.
- The machine is not intended for use by persons (including children) with reduced physical, sensory or mental capabilities or by persons lacking the required experience and knowledge.
- Children should be supervised to ensure they do not play with the machine.
- The operating manual should always be available at the machine's place of use and should therefore be stored with the machine.
- Please hand over these documents to the new owner/operator on sale or rental of the device. Have the hand-over confirmed!
- The labels attached to the machine provide important information for safe operation. Renew labels that are no longer legible or present.
- Only wheels (wheel tyres) approved by Hako may be used.
- With Hako-AntiBac® machine variants, the plastic inner surface of the fresh water and waste water tanks contains silver ions in nanoparticle form.
- Spare parts must be original spare parts to guarantee safety.

## **1.3 Operating safety instructions**

### **1.3.1 Before putting into service**

- Before initially starting up the machine, charge the used battery fully and appropriately with commissioning charge. Please observe the operating manual of the charger and the operating manual of the battery manufacturer. Hako assumes no liability for battery damage resulting from insufficient commissioning charge.
- Check the machine for operating safety before every start-up! Eliminate faults immediately.
- Before starting work, the operator must familiarize himself with all equipment, operating and actuating elements as well as with their function. It is too late to do this during operation!

### **1.3.2 During operation**

- Sturdy and slip-proof shoes must be worn when working with the machine.
- Only those surfaces approved by the contractor or its authorised representative for use of the machine may be driven on.
- If the machine is used in areas in which objects may fall down, this is only permitted if it has an overhead guard which protects the driver.
- When working with the machine, pay special attention to third persons, especially children.
- When driving over thresholds, raise the brush head.
- Only use detergents suitable for automatic machines (foam retarded) and observe the application, disposal and warning instructions provided by the detergent manufacturer.
- The machine and the pre-sweep suction unit are not suitable for removing combustible or explosive liquids, dust or materials that are hazardous to health. It is also prohibited to collect burning objects, e.g. glowing cigarettes. The collection of wood dust, e.g. beech and oak dust, is also prohibited – health hazard!
- Excessive quantities of dust must be avoided when working with the side brush unit or the pre-sweep suction unit!
- The machine is not suitable for collecting large quantities of water, e.g. in the event of flooding.

- For reasons of safety, the driver's seat is equipped with a seat contact switch. The machine can only be started when the driver is sitting on the driver's seat. The function of the seat contact switch must not be bypassed.
- The machine must not be used in potentially explosive atmospheres.
- It is not permitted to transport other people or heavy objects.
- When transporting the machine, raise the squeegee and the brush head. Adjust your way of driving to local conditions.
- Drive slowly on wet surfaces, particularly in bends, due to the risk of skidding.
- Drive slowly into the bend when driving downhill.
- Manipulating the switches and protective devices is forbidden.

**Machine with standard drive:**

- For cleaning purposes, the machine may only be used on a surface with a maximum slope of 6 % for two minutes.
- Transport journeys on slopes of up to 10 % may only take place for one minute and with special caution.

**Machine with X-AC drive:**

- Cleaning may only be carried out on slopes of up to 15 % for a duration of up to 5 minutes.
- Transport journeys on slopes of up to 18 % may only take place for a maximum duration of 3 minutes.  
The machine must not be parked on an uphill or downhill gradient greater than 15 %!

**Dirt hopper:**

- Ensure there is sufficient ventilation when carrying out sweeping work in enclosed rooms.
- The permissible total weight of the dirt hopper must not be exceeded. Monitor the filling level of the dirt hopper at regular intervals.

**1.3.3 After operation**

- Remove the key when leaving the machine to prevent unauthorised use.
- After use, park the machine in a dry, indoor location with the brush head and squeegee raised.

## **1.4 Maintenance instructions**

- Daily and weekly maintenance work must be done in accordance with the maintenance plan by the operating staff. In all other maintenance work, please contact your nearest Hako service centre.
- The maintenance work and maintenance intervals specified in the operating manual must be complied with.
- Suitable tools and protective clothing such as gloves and safety goggles must be used during cleaning and maintenance work.
- Have the machine checked for safe condition by an expert in accordance with the accident prevention regulations at appropriate intervals (we recommend at least once yearly).
- Spare parts must at least comply with the technical requirements specified by the manufacturer. This is guaranteed by original spare parts.
- Turn the machine off and disconnect the battery plug when maintaining the machine and before replacing parts.
- To prevent unauthorised use of the machine, remove the ignition key.
- Cleaning the machine with a high-pressure cleaner or steam jet is not allowed.
- Application of aggressive and corrosive detergents is not allowed.
- After cleaning, let the machine air dry, e.g. over the weekend.
- Only put the machine into service when all the protective devices are attached and in protection position.

### **Pre-sweep suction unit**

- Shaking the filter is only permitted with the dirt hopper inserted.
- Only tip out the contents of the dirt hopper from a low height in order to prevent the formation of dust.
- The dirt hopper must be cleaned at regular intervals to prevent the accumulation of bacteria.

## **1.5 Information about special risks**

### **1.5.1 Electrical system**

- If the electrical system is faulty, always turn off the machine, disconnect the battery and eliminate the fault.
- Work on the electrical system may be done only in accordance with electrical engineering standards by a specialist trained for this work.
- Regularly inspect/check the electrical system of the machine. Defects such as loose connections, loose nuts of electrified bolts, electrical components or damaged cables must be eliminated immediately.
- Only use original fuses with the specified current. If stronger fuses are used, the electrical system can be destroyed and fires may occur.

### **1.5.2 Batteries**



- Observe the operating manuals and safety instructions provided by the battery manufacturer.
- Never connect or disconnect batteries when the machine is turned on.
- Make sure the batteries are never fully discharged; recharge them as quickly as possible.
- Only instructed maintenance personnel must handle and replace batteries.
- Only batteries approved by Hako may be used at the intended position.
- **Danger!** Make sure that the insulation of the battery cables is not damaged. The battery cables should not rub against anything. If the insulation is defective, no longer use the machine and have the battery cables replaced by the Hako customer service immediately.
- **Caution!** Always make sure that the batteries are clean and dry to avoid creeping currents and corrosion damage. Protect the batteries, in particular, against conductive contamination, e.g. metal dust.
- Risk of short circuits and spark formation! Never place tools or other electrically conductive objects on the battery!
- Do not remove insulating caps and covers, if necessary re-install them after carrying out work on the battery cables.

## *Safety instructions*

- Caution! Explosive gases can develop when charging the batteries. Avoid smoking, fire or naked light in the vicinity of batteries. Ensure sufficient ventilation when charging the batteries.
- For further safety instructions, see Hako supplementary sheet 88-60-2556 – information for drive batteries.

## 1.6 Environmental protection instructions and disposal

If the end of use of the machine or of its components is reached and this is handed over for scrapping, the components must be correctly disposed of. Further information about disposal is available through the competent local authorities and the authorised Hako dealers.

	Do not dispose of products with this symbol in domestic waste. Disposal takes place through local collecting points or the manufacturer.
	Recycle used materials with this symbol according to their labelling and do not dispose of them in domestic waste.

- Observe the applicable laws and local regulations when disposing of dirt, waste water and detergents, also see the German Water Resources Law (WHG).
- Used batteries with the recycling symbol contain reusable commodities. In accordance with the symbol showing the crossed-out garbage bin, these batteries must not be disposed of in the domestic waste. Return and recycling have to be arranged with the authorised Hako dealer as required in § 6 and § 8 of the German battery law (BattG)!
- Observe the local regulations when disposing of the AntiBac® tanks, e.g. take the AntiBac® tanks to a suitable disposal site or incineration plant.

### 1.7 Labels on the machine

The following safety and instruction labels are affixed to the machine in a clearly visible and legible manner.



**Attention**

Renew missing or illegible labels immediately!

**A**

**B**

**C**

**D**

<b>Hako</b>	Hako GmbH D-23840 Bad Oldesloe Made in Germany	CE
Typ	_____	
Herstell-Nr	_____	
Gesamtgewicht kg	_____	

**E**

**ACHTUNG:** Explosive Gase – Flammen und Funken vermeiden – Während des Ladens für ausreichende Belüftung sorgen.

**Caution:** Explosive gases – Avoid fires and sparks – Provide for sufficient ventilation during loading!

**Précaution:** Gaz explosifs – Eviter des flammes et étincelles – Pourvoir suffisante ventilation pendant chargement!

**F**

36 V

Fig. 1:



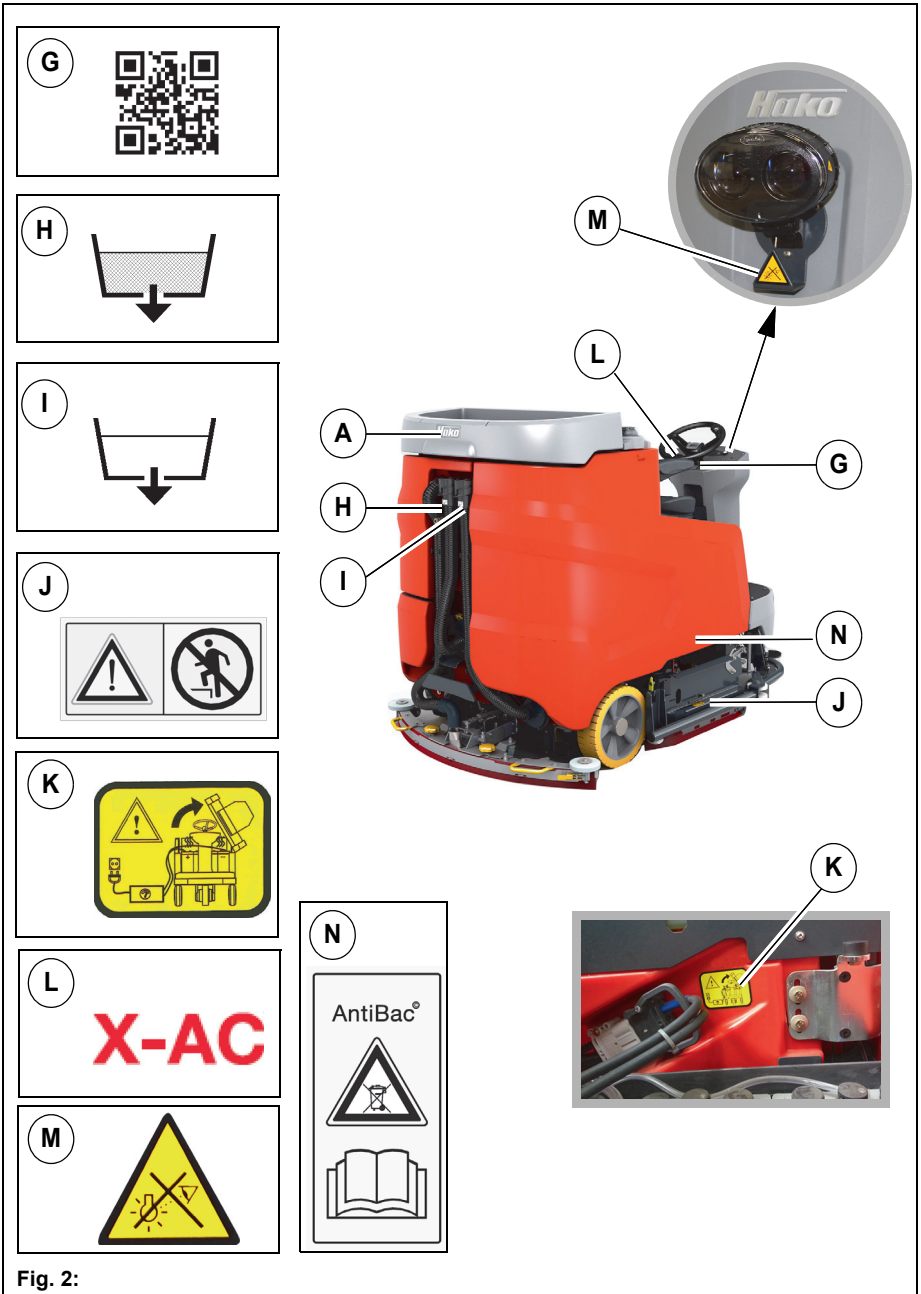

Fig. 2:

**Label – Company logo Fig. 1/ Fig. 2-A**

The Hako logo is located at the front on the steering column and at the rear on the hopper.

**Label**

- **Read and observe the operating manual Fig. 1-B1**
- **Maximum permissible slope 6 % when cleaning Fig. 1-B2**
- **Never clean the machine with a high-pressure cleaner Fig. 1-B3**

The label is located on the left hand side next to the driver's seat.

**Label – Maintenance parts (yellow dot) Fig. 2-C**

The yellow dot is located on the cover of the fresh water filter.

**Type plate Fig. 2-D**

The type plate is located in front of the left front wheel.

**Label – Explosive gases Fig. 1-E**

The label is in the battery compartment.

**Label – 36 V Fig. 1-F**

The label is in the battery compartment.

**Label – QR code Fig. 2-G**

The label is located on the control panel.

**Label – Drain waste water Fig. 2-H**

The label is located on the drain hose of the waste water tank.

**Label – Drain fresh water Fig. 2-I**

The label is located on the drain hose of the solution tank.

**Label – Keep off! Fig. 2-J**

The label is located on the rotating brush or roller brush unit.

**Label – Leave seat console open during the charging procedure! Fig. 2-K**

There is a label in the battery compartment.

**Label – X-AC-drive Fig. 2-L**

For machines with X-AC-drives, the label is located on the control panel.

**Label – Avoid looking directly at the light!**

The label is located on the Blue Spot (option).

**Printing – Do not dispose of AntiBac® tanks in the domestic waste! Fig. 2-N**

The printing is located on the AntiBac® tanks.

## 1.8 Labels on the pre-sweep suction unit

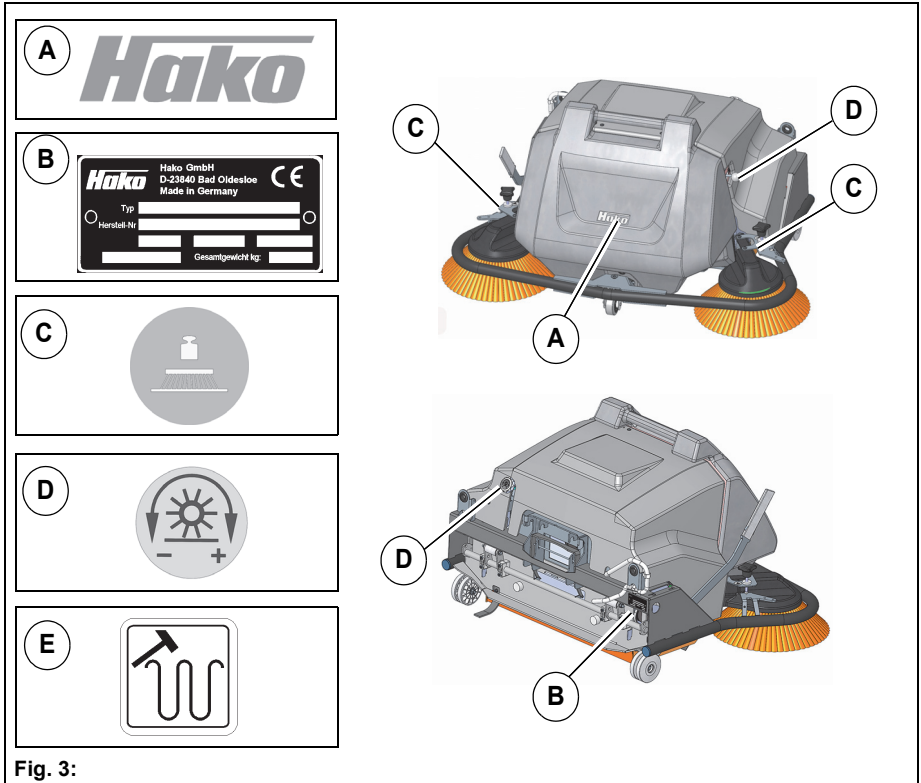

Fig. 3:

### Label – Logo Fig. 3-A

The Hako logo is located on the front of the dirt hopper.

### Type plate Fig. 3-B

The type plate is located at the rear right-hand side of the pre-sweep suction unit.

### Label – Side brush wear compensation Fig. 3-C

The labels are located on the right and left next to the side brush adjustment.

### Label – Cylindrical brush wear compensation Fig. 3-D

The label is located on the cylindrical brush adjustment.

### Label – Shaking system Fig. 3-E

The label is located on the left hand side of the shaking system.

## 2 Operation

### 2.1 Overviews

The description in chapter 2 contains information on the function and handling of the individual controls on the machine. The controls always have the same item number in all chapters.

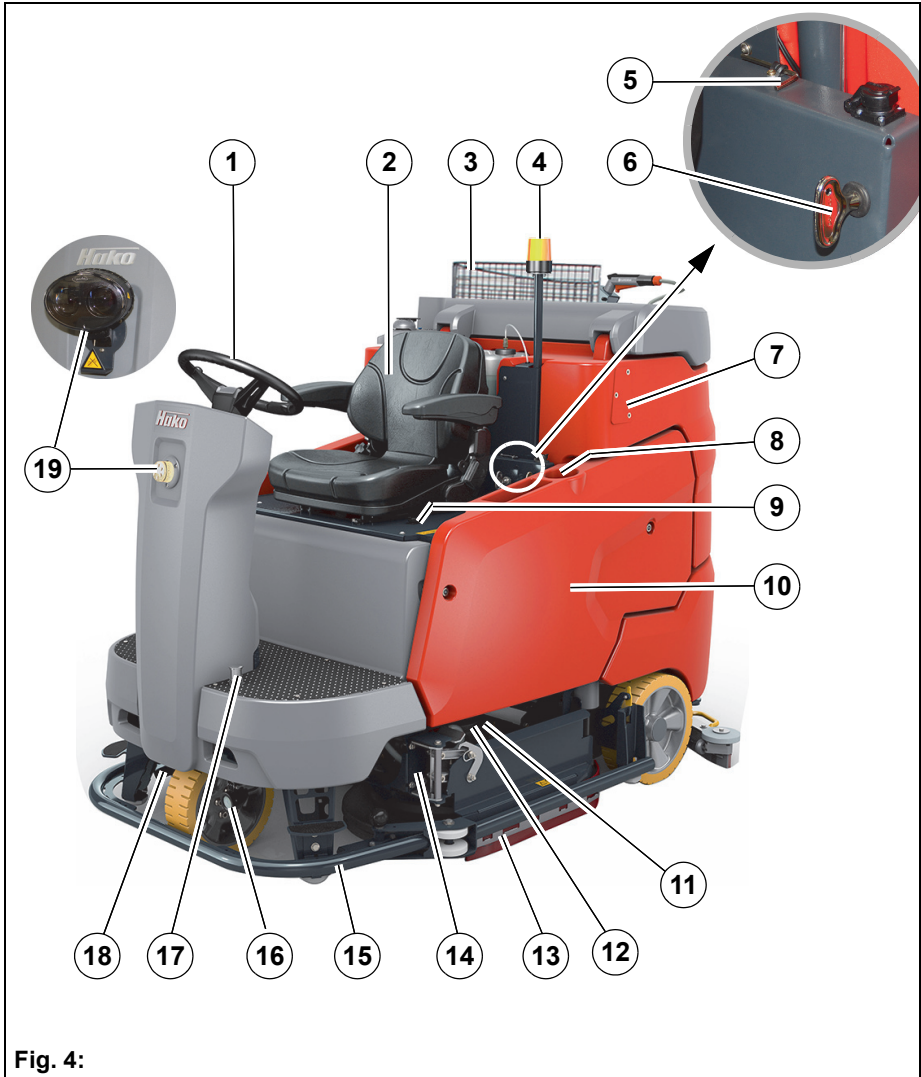

Fig. 4:

### 2.1.1 Front view

Item	Designation
1	Steering wheel
2	Driver's seat
3	Tray
4	Flashlight on a pole
5	Key for electronics cover
6	Key for side panelling
7	Holder for manual suction tool or manual spray suction tool
8	Drinks holder and storage compartment
9	Socket for USB connection
10	Side panelling
11	Ball cock
12	Fresh water filter
13	Wiper
14	Side brush unit
15	Front collision protection
16	Working light
17	Operating brake
18	Travel drive
19	Warning device or Blue Spot

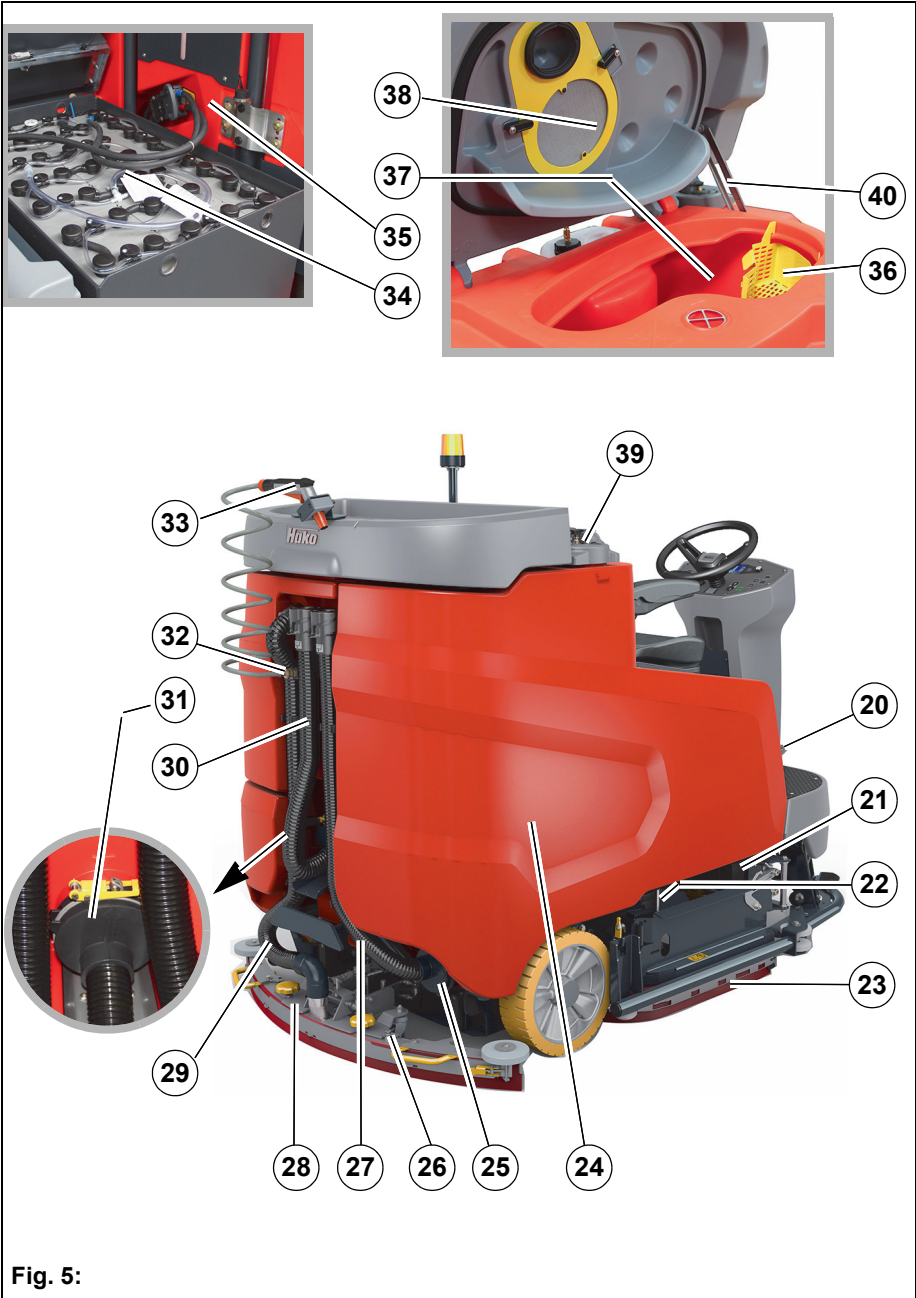

Fig. 5:

### 2.1.2 Rear view

Item	Designation
20	Accelerator pedal
21	On-board dosing system
22	Brush unit
23	Wiper
24	Solution tank
25	Maintenance opening solution tank
26	Squeegee water connection
27	Fresh water drain hose
28	Squeegee
29	Suction hose
30	Drain hose waste water
31	Waste water tank maintenance opening
32	Water connection
33	Spray nozzle
34	Battery compartment
35	Battery plug
36	Coarse dirt sieve
37	Waste water tank
38	Intake sieve
39	Filling opening
40	Automatic filling unit

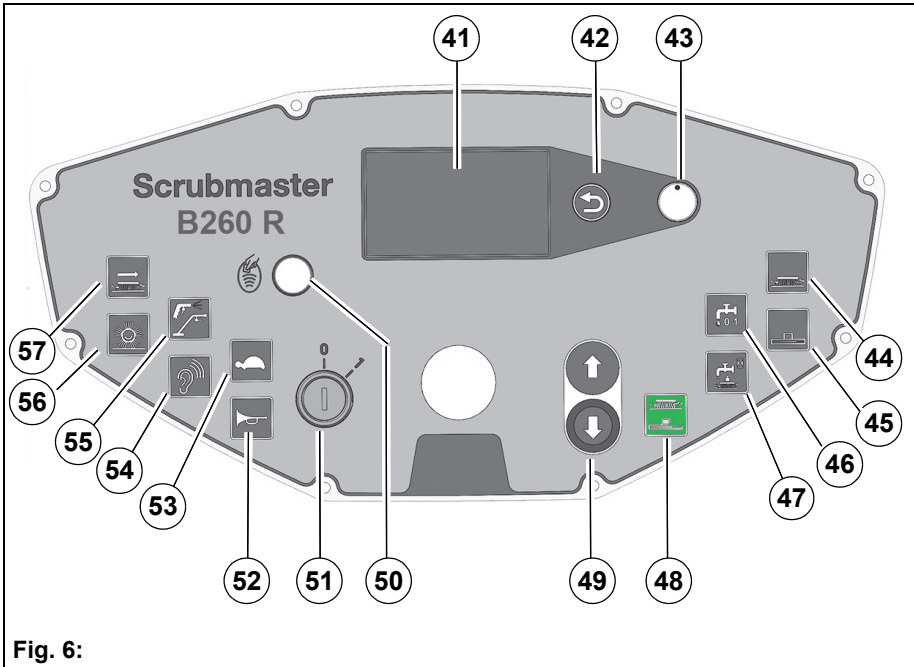

Fig. 6:

### 2.1.3 Control panel

Item	Designation
41	Multifunction display
42	Return button
43	Turn-push knob
44	Button – brush unit
45	Button – squeegee
46	Button – fresh water supply
47	Button – boost function
48	Button – brush unit and squeegee
49	Button – driving direction selection
50	iButton Reader (option)



51	Key switch
52	Button – signal horn
53	Button – speed reduction forwards gear
54	Button – silent operation
55	Button – tool operation
56	Button – pre-sweep suction unit
57	Button – side brush unit

## 2.2 Controls and display elements

### 2.2.1 Control panel

The individual functions of the buttons on the control panel are described below. The respective activated functions are visible as corresponding symbols in the multifunction display.



#### Key switch Fig. 6-51

The electrical system is switched on and off with the key switch.

- Position 0: The electrical system is switched off. The key can be pulled out.
- Position 1: The electrical system is switched on.
  - The software version is displayed for approx. 1 second on the multifunction display, followed by the last service code for approx. 3 seconds if necessary. The operating hours meter is then displayed.

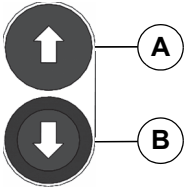

#### Driving direction selection button Fig. 6-49

The driving direction is selected with this button. The driving direction can be changed while driving.

- Push the button (A): Forwards gear
- Push the button (B): Reverse gear



#### Note

A warning signal is output when in reverse gear. The maximum speed when reversing is half of the maximum speed when driving forwards.



### Speed reduction button Fig. 6-53

The maximum speed when driving forwards is reduced by approx. 50 % with this button.

- Push the button: Speed reduction ON
- Push the button again: Speed reduction OFF



### Signal horn button Fig. 6-52

The signal horn is switched on and off with this button.

- Push the button: Signal horn ON
- Release the button: Signal horn OFF



### Fresh water supply button Fig. 6-46

The fresh water supply is switched on and off with this button.

- Push the button: Fresh water supply ON
- Push the button again: Fresh water supply OFF

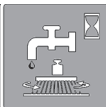

### Boost function button Fig. 6-47

In order to remove heavy contamination, it is possible to boost the scrubbing-vacuuming cleaning program (green button **Fig. 6-48**) and scrubbing (button **Fig. 6-44**) using the boost function.

- Push and hold the button: the highest level of fresh water dosing and the increased brush pressure are activated simultaneously.
- Release the button: the machine switches back to the operating mode it was in before the boost function.



### Brush unit button Fig. 6-44

The brush unit is lowered and raised with this button.

- Push the button: The brush unit is lowered. When actuating the accelerator pedal, the brush drive and the water supply are switched on.
- Push the button again: The brush drive and the water supply are switched off. The brush unit is raised.



#### Note

If the accelerator pedal is not actuated, the brush drive and the water supply are switched off.



### Squeegee button Fig. 6-45

The squeegee is lowered/raised and the suction turbine switched on and off with this button.

- Push the button: The squeegee is lowered and the suction turbine switched on.
- Push the button again: The squeegee is raised. After an after-run time of approx. 15 seconds, the suction turbine is switched off.



#### Note

The squeegee is automatically raised when reversing. The suction turbine drive remains switched on.



### Brush unit and squeegee button Fig. 6-48

The brush and suction turbine drive are switched on and off simultaneously with this button.

- Push the button: the brush unit, the side brush unit and the squeegee are lowered, and the suction turbine is switched on. The brush drive and the water supply are switched on when the accelerator pedal is actuated.
- Push the button again: the brush unit and the side brush unit are raised. The brush drive and the water supply are switched off. The squeegee continues to run for approx. 15 seconds to absorb residual water.



### Side brush unit button Fig. 6-57

The side brush unit is switched on and off with this button.

- Push the button: Side brush unit ON
- Push the button again: Side brush unit OFF



### Pre-sweep suction unit button Fig. 6-56

The pre-sweep suction unit is switched on and off using the button.

- Push the button: Pre-sweep suction unit ON
- Push the button again: Pre-sweep suction unit OFF



**Tool operation button Fig. 6-55**

The following tools can be switched on and off using this button when the driver is not on the seat:

- Spray nozzle
- Manual suction or spray suction tool

If the machine does not have a particular tool, it is excluded from the switching order

- Push the button: Spray nozzle ON
- Push the button twice: Manual suction and spray suction tool ON
- Push the button again: Tool operation OFF



**Button – silent operation Fig. 6-54**

The suction turbine is switched to silent operation with this button.

- Push the button: Silent operation ON
- Push the button again: Silent operation OFF



**iButton Reader (option) Fig. 6-50**

The iButton Reader is used to activate the functions.

Red illuminated LED or warning sound after switching on the machine request the activation of the operating data recording system via the iButton Key.

- Push the iButton Key for approx. 2 seconds against the iButton Reader.

The red LED goes out. The machine is ready for operation.

## 2.3 Multifunction display

The functions and indicators of the machine are set and displayed with the multifunction display. After the machine is switched on, the operating system and data are loaded and the start screen appears on the display. After several seconds the view changes, and the main menu **Fig. 7-A** appears. By selecting and confirming the soft key *Menu selection* **Fig. 7-B** you are taken to the sub-menu **Fig. 7-C**.



### Note

It is only possible to switch to the sub-menu if the cleaning functions are switched off!

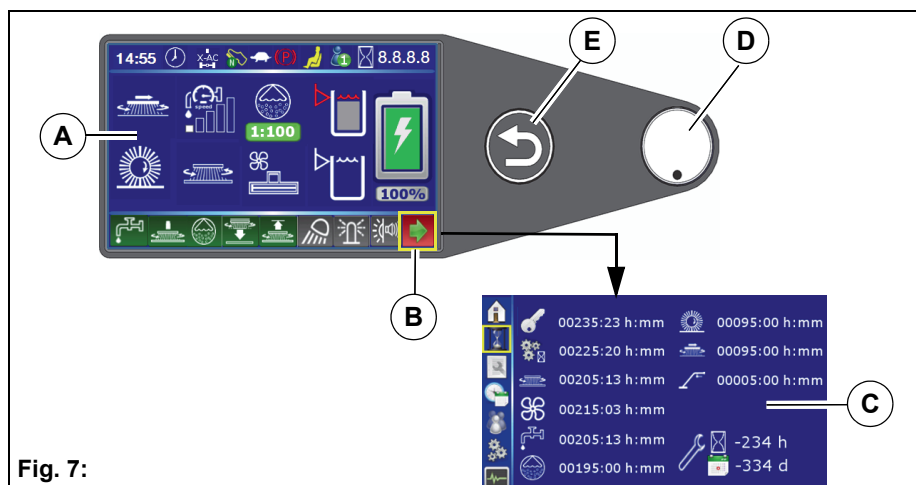

### 2.3.1 Menu guidance

The menu is operated with the turn-push knob **Fig. 7-D**.

Menus and sub-menus are selected in the multifunction display and the individual menu item values are set or changed with the turn-push knob. The following basically applies:

- Turn to select a menu item. The selected menu item is displayed with a yellow border.
- Push to activate a menu item.

You can jump back to the previous menu using the return button **Fig. 7-E**.

### 2.3.2 Main menu

The main menu is divided up into three levels.

- Status level **Fig. 8-A**
- Function level **Fig. 8-B**
- Action level **Fig. 8-C**

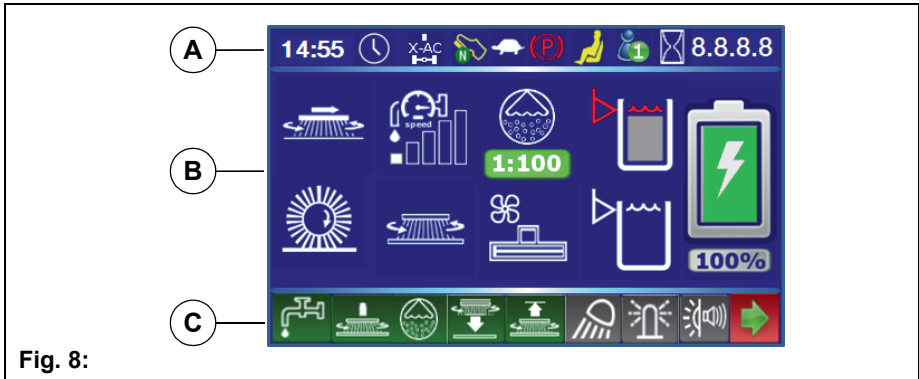











Fig. 8:

#### Symbols at status level













Symbol	Designation	Meaning
	Service alarm clock	Service alarm clock active.
	Service alarm clock	If the service alarm clock has elapsed, this symbol is permanently visible.
	X-AC drive	The symbol appears for two seconds if the X-AC drive is installed.
	Driving direction	The selected driving direction is displayed as a respective symbol. Example: forwards gear.
	Accelerator pedal in neutral position	This symbol appears when the accelerator pedal is in the neutral position.







	Speed reduction	The symbol is displayed when the machine is driving at reduced speed.
	Parking brake	The symbol is displayed when the parking brake is activated.
	Rear wheel parking brake is not operational	The symbol appears if the rear brake has been taken out of service mechanically. Driving is deactivated.
	Seat contact	The warning symbol lights up if the driver gets up from the driver's seat during operation. Main functions, e.g. scrubbing, vacuuming and driving, are no longer possible.
	User	The symbol indicates the currently set user profile.
	Silent operation	The symbol appears when the machine is working in reduced-noise operation. The symbol also appears at the <i>Squeegee</i> symbol.
	Operating hours meter	The operating hours in work mode are displayed. The operating hours for the individual units can be called up in the sub-menu.
	Service alarm clock	If the service alarm clock <i>Operating hours</i> has elapsed, this symbol is permanently visible.
	Service indicator	The symbol appears if a service case occurred, but it had already been eliminated automatically or by operator intervention.
	Service indicator	The symbol appears if a service case occurs. An acoustic warning is also output and a four-digit service code appears on the right next to the symbol, see section 3.6.

### Symbols at function level





All active units are displayed as symbols at function level.

Symbol	Designation	Meaning
	Side brush unit	Side brush unit active.
	Pre-sweep suction unit	Pre-sweep suction unit active.
	Speed-independent water dosing	The selected water dosing is displayed in the bar diagram.
	Speed-dependent water dosing	The selected water dosing is displayed in the bar diagram. Water quantity adaptive to driving speed.
	On-board dosing system	On-board dosing system active. The currently set mixing ratio is displayed.
 	Rotating brush unit Roller brush unit	Brush unit active.
 	Increased brush pressure, rotating brush Increased brush pressure, roller brush	Brush unit operating with increased brush pressure. At maximum brush pressure, two weights appear in the symbol.
	Squeegee	Squeegee and suction turbines active.
 	Manual suction/ spray suction tool	Manual suction tool or spray suction tool active.  The suction for the spray suction tool can be deactivated by pressing the <i>squeegee</i> button.
	Spray nozzle	Spray nozzle active.

	Solution tank full	The current filling level of the solution tank is shown descending in steps of 20 %.
	Warning symbol – solution tank empty	The symbol appears when the filling level of the solution tank is approximately 10 litres. A warning sound is additionally output. Fill the solution tank immediately, see section 5.3.1,
	Waste water tank full warning symbol	The symbol appears when the waste water tank is full. An acoustic warning is also output, and waste water collection is switched off. Empty the waste water tank immediately, see section 5.4.1.
	Warning symbol – dirt hopper of the roller brush unit full	When switching off, the fill level is checked in the dirt hopper. The symbol is displayed when the dirt hopper is full. A warning sound is additionally output. Emptying the dirt hopper,
	Battery charging state indicator	The current charge level of the battery is displayed in steps of 10 %, see section 5.2.1,

### Additional symbols

For more information there are additional symbols, which are explained in the following

Symbol	Designation	Meaning
	Warning symbol – red spanner	Faults in the functions are signalled by the red spanner. A 4-digit service code is also displayed at the same time.
	Warning symbol	If this symbol appears, the unit <ul style="list-style-type: none"> <li>• is not installed or</li> <li>• not configured</li> </ul> Example: pre-sweep suction unit not installed.
	Symbol <i>OFF</i>	If the symbol appears, the function is switched off. Example: the water supply is switched off.
	Function symbol displayed in yellow	Interrupted functions are shown in yellow, e.g. if the accelerator pedal is in the neutral position. Example: function interrupted by brush unit.
	Symbol displayed in grey	If a symbol appears in grey, the function cannot be started because the prerequisites for starting have not been fulfilled. Example: switch to sub-menu not possible.



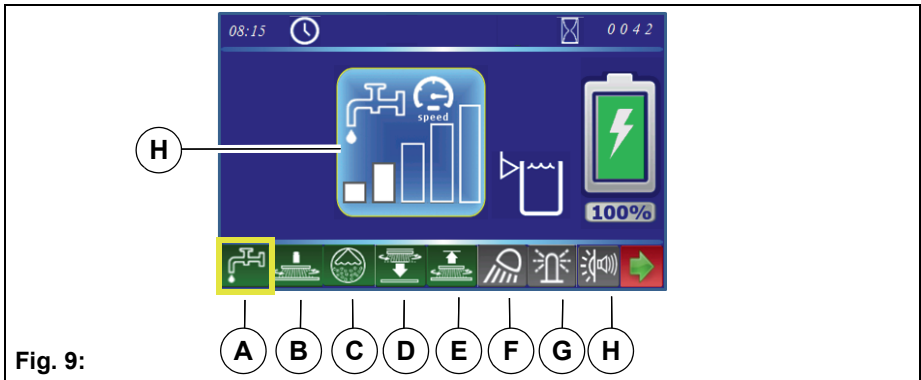

**Action level**





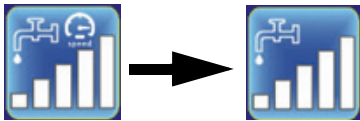

Settings can be made or actions performed in the action level using soft keys **Fig. 6-A to G**.



The soft keys are selected by rotating the turn-push knob (soft key with yellow border) and confirmed by pressing. An action window **Fig. 9-H** opens, in which the settings can be carried out using the turn-push knob. The action windows close automatically after a few seconds or by pressing the return key.

**The following actions are possible:**

Soft key	Action window/ soft key	Setting
<b>A</b> Water dosing	 	Depending on the presetting, the action window appears for speed-dependent or speed-independent water dosing. <ul style="list-style-type: none"> <li>• The water dosing has 5 settings.</li> <li>• After reaching the highest speed-dependent water quantity, the speed dependence is deactivated by turning the turn-push knob clockwise.</li> </ul> 
<b>B</b> Brush pressure increase		Brush pressure increase OFF 1 weight = increased brush pressure 2 weights = maximum brush pressure Green background = active

<p><b>C</b> On-board dosing system</p>		<p>Setting the mixing ratio, see section 3.4.2.</p>
<p><b>D</b> Ejecting the rotating brushes</p>		<p>Ejecting the rotating brushes, see section 5.5.3.</p>
<p>Replacing the roller brushes</p>		<p>Roller brush change position,</p>
<p><b>E</b> Coupling the brushes</p>		<p>Coupling the rotating brushes, see section 5.5.4.</p>
<p><b>F</b> Working light</p>		<p>Working light ON/OFF by means of direct selection using the soft key. If the working light is switched on, the colour of the soft key changes from white to green.</p>
<p><b>G</b> Flashlight</p>		<p>Flashlight ON/OFF by means of direct selection using the soft key. If the flashlight is switched on, the colour of the soft key changes from white to green.</p>
<p><b>H</b> Warning device forwards gear or Blue Spot</p>		<p>The following settings can be selected in the action window:</p> <ul style="list-style-type: none"> <li>• Turn indicator ON/OFF</li> <li>• Acoustic warning ON/OFF</li> <li>• Turn indicator and acoustic warning ON/OFF</li> </ul> <p>If the respective function is switched on, the colour changes from white to green.</p>

### 2.3.3 Sub-menu

Configuration can be carried out, operating data read off and the clock/calendar set in the sub-menu. Some sub-menus require additional access rights. After calling up the sub-menu, the cursor automatically jumps to the operating hours menu.

To return to the main menu, press

- the soft key *Home* **Fig. 10-A** or
- the return key on the control panel **Fig. 10-42**.

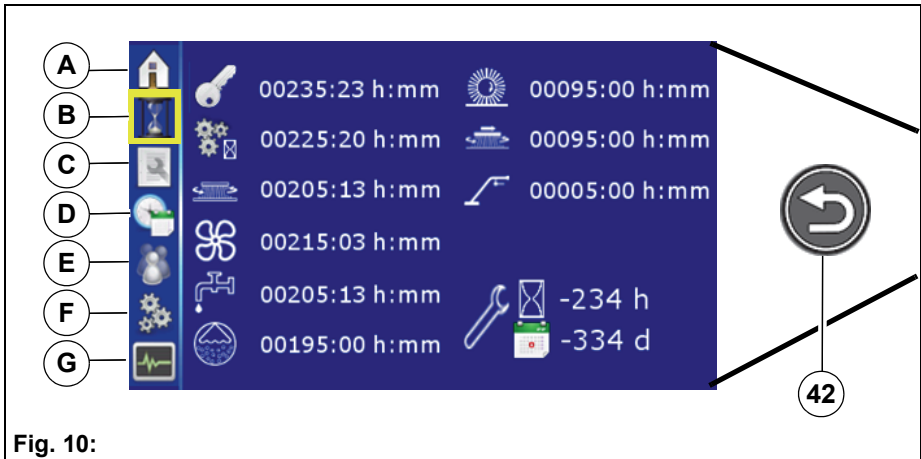

Fig. 10:

The following sub-menus can be selected:

<p><b>Operating hours meter menu Fig. 10-B</b></p>	
<p>00235:23 h:mm    00095:00 h:mm          00225:20 h:mm    00095:00 h:mm          00205:13 h:mm    00005:00 h:mm          00215:03 h:mm          00205:13 h:mm    -234 h          00195:00 h:mm    -334 d</p>	<ul style="list-style-type: none"> <li>As well as the machine activation time and work mode, the operating hours of the individual units are displayed.</li> <li>The remaining time until the next service is displayed in hours/days at the bottom right. If a service is required, the spanner appears in red.</li> </ul>
<p><b>Maintenance menu Fig. 10-C</b></p>	
	<p>The maintenance menu contains the following menu items:</p> <ul style="list-style-type: none"> <li>The <i>Maintenance instructions</i> sub-menu.</li> <li>Activation/deactivation of speed-dependent water dosing.</li> <li>Activation/deactivation of automatic squeegee cleaning.</li> <li>The <i>information menu</i> contains information about software and hardware revisions.</li> <li>To put the on-board dosing system into service, the detergent is conveyed to the brush unit by activating the <i>fast-fill menu</i>.</li> </ul>
	<p>The <i>Maintenance instructions</i> sub-menu opens, in which pictures for daily cleaning and maintenance are stored.          Example: cleaning the fresh water filter.</p> <p>When this menu is exited, a diskette appears. By selecting and confirming the <i>Diskette</i> symbol, you are confirming that you have carried out the maintenance.</p>
	<p>Speed-dependent water dosing ON/OFF.</p>
	<ul style="list-style-type: none"> <li>Automatic squeegee cleaning ON.</li> <li>The time display in 5 second steps signals the time until shut-off.</li> <li>Automatic squeegee cleaning OFF.</li> </ul> <p>see section 5.7.1</p>

**Maintenance menu Fig. 10-C continued**



- Fast-fill menu ON
  - Program continues to the end and finishes automatically
- see section 3.4.2

**Time/Date menu Fig. 10-D**

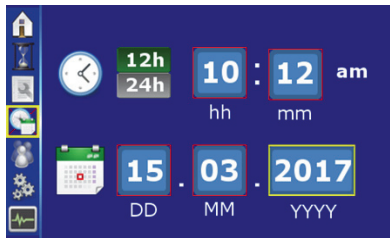

- Time:**
- Choice between 12 hour or 24 hour display.
  - Set the clock in hours and minutes.
- Date:**
- Set the date: day, month and year.
- The set values are taken over when the menu is exited.

**User settings menu Fig. 10-E**



- The *user settings* menu contains:
- Selection of:
    - Specified settings (1-6)
    - User-specific settings (A-C)
  - Definition of:
    - User-specific settings (A-C)



- 9 settings are available in the selection menu:
- The specified settings (1-6) contain predefined standard procedures.
  - User-specific settings (A-C) contain user-defined function procedures and function restrictions.



The selected, active user profile is displayed as a number/letter with a green background.



3 programs (A, B, C) with user-specific settings can be stored in this configuration menu. The modification of user profiles requires additional access rights.



Configuration menu Fig. 10-F



The following settings are made in the configuration menu:

- Activate/deactivate options.
- Setting of machine-specific parameters.

Making changes to the configuration menu requires additional access rights.

Service information menu Fig. 10-G

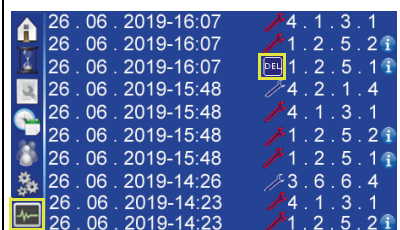

The last 10 items of service information are displayed in the service information menu. The operator can perform the following actions:

- Delete the last service information when the fault has been remedied.
- Obtaining detailed information.



Deletion of the last service information from the display:

Select the *Delete* symbol with the turn-push knob and press the turn-push knob for 3 seconds.

The *Delete* symbol is now no longer visible and the service code is no longer displayed after starting up the machine.



If the *Information* symbol appears next to the service code, detailed information can be requested.



Select the *Information* symbol with the turn-push knob and confirm. Another window opens in which detailed information is displayed.

Example: brush motor overheating

### 2.3.4 Controls at the machine

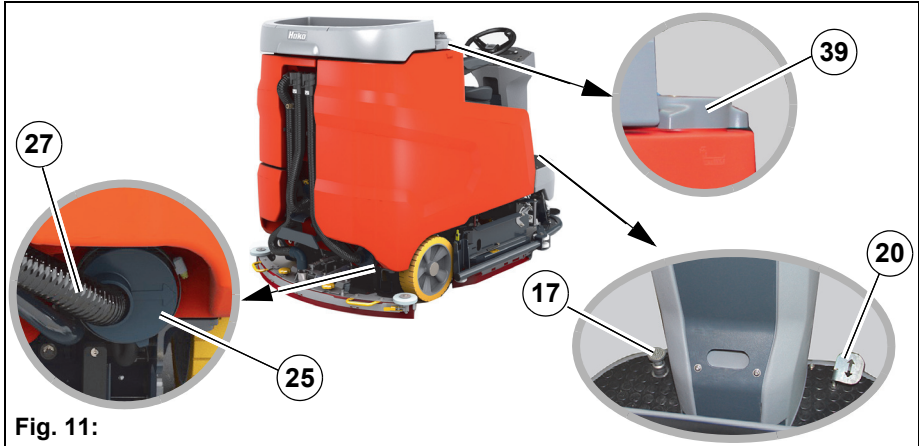

Fig. 11:

#### **Operating brake Fig. 11-17**

When the accelerator pedal is released, the machine comes to a stop due to the braking effect of the travel drive. If this braking effect is not sufficient, the operating brake can be applied in addition.

#### **Accelerator pedal Fig. 11-20**

The accelerator pedal is used to drive forwards or reverse and continuously adjust the speed at the same time.

If the accelerator pedal is not actuated, it automatically returns to the zero position and the machine stops.

#### **Filling opening fresh water Fig. 11-39**

The solution tank is filled via the filling opening. If the solution tank is filled using fast filling, the grey cover can be removed to increase the size of the filling opening.

Optionally, the solution tank can be filled via the automatic filling unit, see section 5.3.1.

#### **Fresh water drain hose Fig. 11-27**

The solution tank is drained using the drain hose.

#### **Solution tank maintenance opening Fig. 11-25**

The cleaning opening is used for cleaning the solution tank.

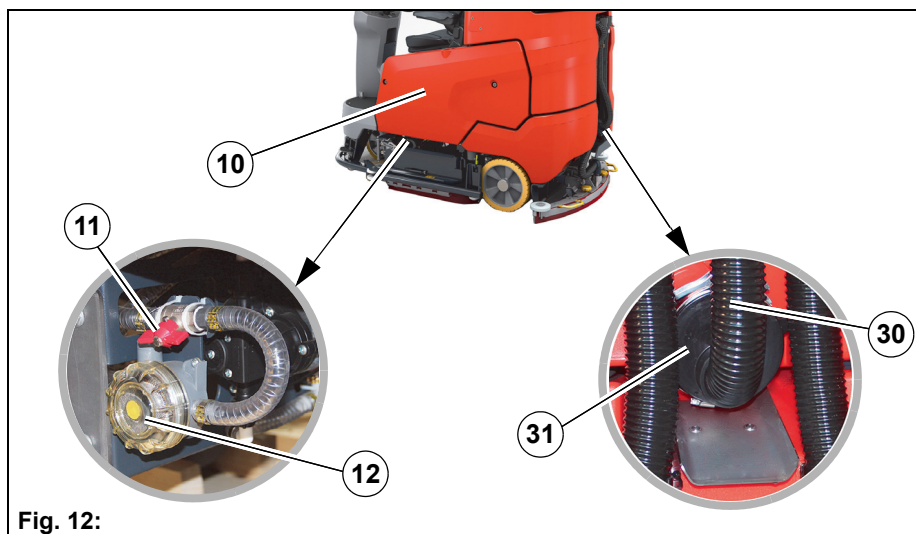

**Fig. 12:**

#### **Side panelling Fig. 12-10**

The trough batteries and the suction turbines are behind the side panelling. The side panelling can be easily removed using the provided wrench.

#### **Waste water tank maintenance opening Fig. 12-31**

The maintenance opening is used to drain the waste water and for cleaning the tank.

#### **Fresh water filter Fig. 12-12**

When supplying water from the solution tank to the brush unit, the fresh water is cleaned by the filter insert.

#### **Ball cock Fig. 12-11**

The ball cock is used to switch the water supply on and off manually in case the fresh water filter needs to be unscrewed.

#### **Drain hose for waste water Fig. 12-30**

The waste water that is collected is drained using the drain hose.

## 2.4 Functional description:

Scrubmaster B260 R is a ride-on scrubber-drier for wet cleaning hard floor surfaces. The Scrubmaster B260 R is intended for economical cleaning of large operational areas.

In cleaning mode, the cleaning solution is supplied from the solution tank to the rotating brushes in the brush unit. When the machine is moving forwards, the used waste water is absorbed by the squeegee and conveyed into the waste water tank.

A seat contact ensures that the machine can only be operated when the operator is sitting on the seat.



Fig. 13:

### 2.4.1 Solution tank

The solution tank **Fig. 13-24** is filled via the filling opening **Fig. 13-39**. The solution tank has a capacity of 260 litres. The current filling level is shown in the multifunction display. If the filling level is less than 10 litres in the tank, the *Tank empty* symbol appears in the display and an acoustic warning indicates that topping up is required.

### 2.4.2 Rotating brush and roller brush unit

The brushes in the brush unit **Fig. 13-22** are, depending on the actual version, driven by two or three electric motors. The brush unit is lowered with the *Brush unit Fig. 6-44* button. When actuating the accelerator pedal, the brush motors and the water supply are switched on. The floor is cleaned by the rotating brushes and the supply of cleaning solution. The brush pressure can be changed in the multifunction display.

There is an indicator on the brush desk showing the amount of brush wear. The brushes in the rotating brush unit can be ejected for maintenance purposes by pressing the soft key *Brush decoupler Fig. 9-C* in the multifunction display, see section 5.5.3.

### 2.4.3 Side brush unit

In order to brush up coarse dirt close to walls and beyond the squeegee, a side brush unit **Fig. 13-14** with two side brushes can be fitted at the front.

### 2.4.4 Wiper

To the right and left of the brush unit there are two wipers which avoid spray water at the side in the working position and lead the waste water to the centre of the vehicle, where it is easier to vacuum up.

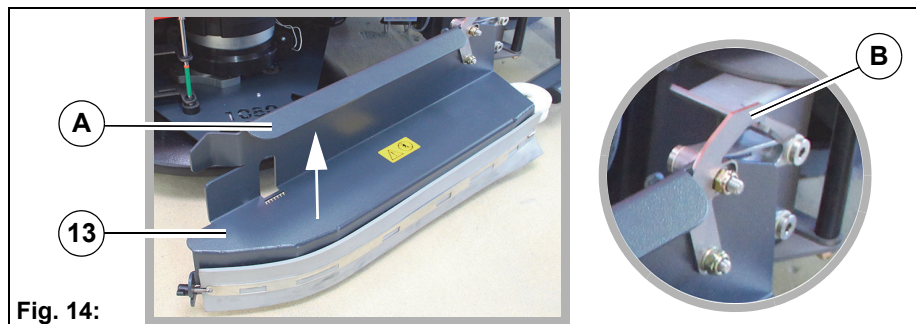

**Fig. 14:**

The wipers can be raised if necessary. To do this, raise the wiper at the handle **Fig. 14-A** and hook the locking hook **Fig. 14-B** into the bracket above it.

### 2.4.5 Squeegee

The movable, hinged squeegee **Fig. 13-28** is lowered and switched on with the *Squeegee* button **Fig. 6-45**. The squeegee withdraws the waste water from the floor using a sealing strip. The suction turbines vacuum the waste water from the floor. If the machine passes through narrow sections, e.g. checkout areas, the squeegee can be removed by loosening the star-shaped handle and hooked into the cover **Fig. 15-A** of the waste water tank. The squeegee can be swivelled up for maintenance purposes **Fig. 15-B**.

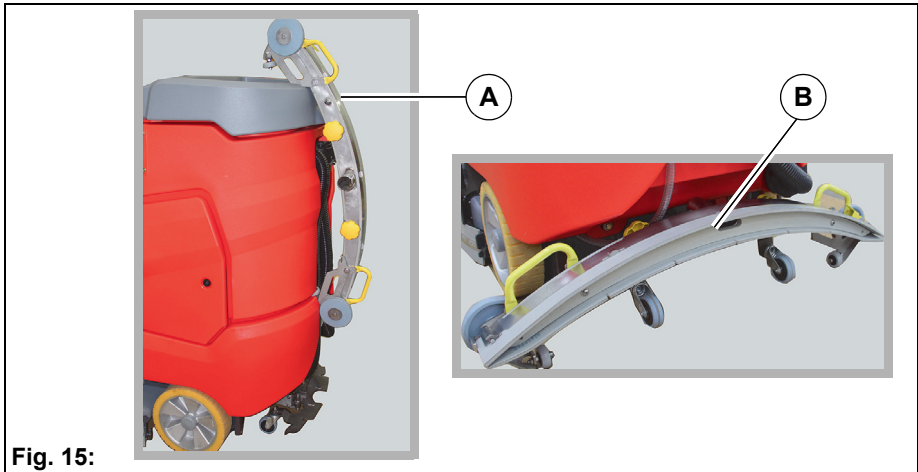

Fig. 15:

### 2.4.6 Waste water tank

The waste water vacuumed by the squeegee is conveyed via a suction hose **Fig. 15-29** from the squeegee into the waste water tank **Fig. 15-37**. A float switch inside the waste water tank automatically switches the suction turbine off when the maximum filling level is reached. In this case, a warning symbol illuminates in the multifunction display. An acoustic warning is output at the same time.

### 2.4.7 Suction turbines

The suction turbines are on the left-hand side of the machine and are accessible after removing the side panelling. The suction turbines are switched on and off automatically when the squeegee is lowered and raised.

## 2.4.8 Travel drive

### Standard

The travel drive consists of an electric machine and a gearbox, and fulfils the functions of driving, braking and steering. Driving and braking are carried out using the electric machine. Steering is carried out using a connected steering rod. The gearbox does not require an oil change.

### X-AC drive (option)

The X-AC drive is an electrical machine with a gearbox on the rear axle which acts as a drive and deceleration aid for the travel drive on the front axle.

## 2.4.9 Brakes

The operator slows down the machine by releasing the accelerator pedal. A greater braking effect is achieved by operating the brake. When the machine comes to a standstill, the parking brake is automatically applied.

## 2.4.10 Batteries

The machine variants may be equipped with different battery types.

- Trough battery 36 V/480 Ah PzS, 320 A wet
- Trough battery 36 V/420 Ah PzV, 320 A maintenance free

### Battery management system (BMS)

The Scrubmaster B260 R is fitted with a BMS. The BMS ensures that the battery system is monitored. The BMS is responsible for:

- determining the battery charging state during operation
- switching off the cleaning functions when the discharge limit has been reached to protect the battery against total discharge



#### Attention

When using other batteries which have been approved by Hako, the BMS must be reset to protect the battery against total discharge. The settings of the BMS should only be carried out by a workshop authorised by Hako!

For more information, see section 5.2.

### 3 Operation

#### 3.1 Instruction

Instruction is required before the first start-up. The first-time instruction of the machine must be provided only by a specialist of your authorised Hako dealer. This person will be notified immediately after delivery of the machine from the factory and will contact you to make an instruction appointment.

#### 3.2 Before putting into service

	<p><b>Attention</b></p> <ul style="list-style-type: none"> <li>• Before initially starting up the machine, charge the used batteries fully and appropriately with commissioning charge. Please observe the instruction manual of the charging device and the instruction manual of the battery manufacturer. Hako assumes no liability for battery damage resulting from insufficient commissioning charge.</li> <li>• Check the machine for operating safety before every start-up! Eliminate faults immediately.</li> <li>• Before starting work, the operator must familiarize himself with all equipment, operating and actuating elements as well as with their function.</li> </ul>
---	---

#### 3.3 Check list: Before machine start-up

	Description
1	Checking the parking area for signs of leaks. Cables and tanks must not show any sign of leaks or damage.
2	Mounting the brushes and squeegee, see chapter Maintenance.
3	Adjusting the driver's seat, if necessary, see section 3.3.1.
4	Adjusting the side mirror (optional), see section 3.3.2.
5	Checking the battery charge and recharge it as required, see section 5.2.2.
6	Emptying the waste water tank and clean it as required, see section 5.4.
7	Filling the solution tank (see chapter Maintenance) and add detergent according to the manufacturer's specifications.



### 3.3.1 Driver's seat



#### Attention

For reasons of safety, the driver's seat is equipped with a seat contact switch. The function of the seat contact switch must not be bypassed.

#### Danger

Do not adjust the driver's seat while driving. Risk of accident!

- Only adjust the seat if the machine is stationary.
- The driver's seat must audibly engage after adjustment.

Adjust the driver's seat in such a way that all controls can be easily reached.

#### Adjusting the standard driver's seat



Fig. 16:

Sit on the driver's seat and adjust as follows:

#### Adjust in longitudinal direction

- Push lever **Fig. 16-A** outwards.
- Move seat forwards or backwards.
- Release lever **Fig. 16-A** and let the driver's seat engage.

#### Adjusting the driver's seat comfort



Fig. 17:

Sit on the driver's seat and adjust as follows:

### Adjust in longitudinal direction

- Push lever **Fig. 17-A** outwards.
- Move seat forwards or backwards.
- Release lever **Fig. 17-A** and let the driver's seat engage.

### Adjusting the tilt of the backrest

Adjust the tilt of the backrest by turning the handwheel **Fig. 17-B**.

### Adjusting the tilt of the armrests

Adjust the tilt of the armrests by turning the wheel **Fig. 17-D**.

The armrests can be folded up when not in use.

### Adjusting the seat suspension

The seat suspension can be continuously adjusted to the weight of the driver (50–120 kg) by turning the handwheel **Fig. 17-C**.

- Drivers who weigh less turn the handwheel **Fig. 17-C** to the left.
- Drivers who weigh more turn the handwheel to the right.

## 3.3.2 Side mirror (optional) adjustment



### Danger

Never adjust the side mirror while driving. Risk of accident!

- Only adjust the side mirror if the machine is stationary.

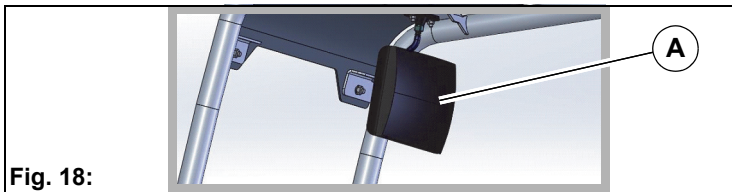

**Fig. 18:**









Adjust the outside mirrors on the overhead guard **Fig. 18-A** so that a full view of the rear working area is provided.

### 3.4 Cleaning



**Attention**

- Before operating the machine, read and observe the safety instructions in chapter 1.
- The machine can only be put into service when the driver is sitting on the driver's seat.
- The travel drive can only be started if the accelerator pedal is not being actuated when the machine is turned on.

		Description
1		Turn on the machine.
2		Activate access authorization using the iButton Key (optional).
3		Use the driving direction selection button to select the driving direction.
4		Select the cleaning programme.
5		Actuate the accelerator pedal. The brush unit and the water supply are switched on with the last selected setting.
6		If necessary, switch on the fresh water supply.
7		Set the fresh water quantity in the multifunction display using soft key <i>Fresh water dosing</i> .
8	 	In the event of heavy soiling, increase the brush pressure using soft key <i>Brush pressure</i> in the multifunction display or press the Boost button for 1 minute.

### 3.4.1 Entry.X (optional)

Access authorization is allocated using entry.X. Entry.X can only be used with view.X.live.

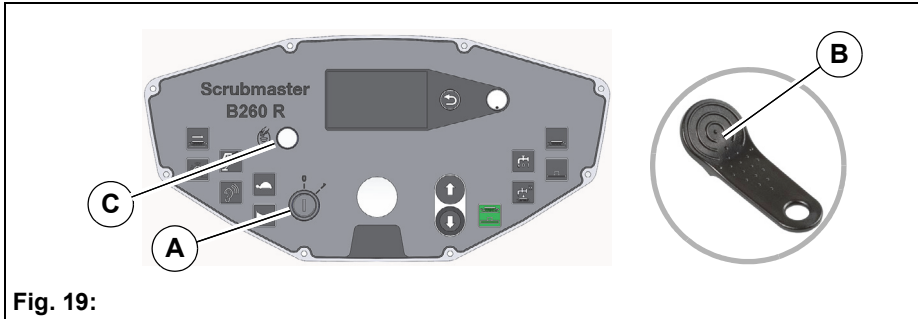

Fig. 19:

#### Putting into service

1. Turn the machine on with the key switch **Fig. 19-A**.
  - Red LED of the iButton Reader ON.
2. Press the iButton **Fig. 19-B** for one to two seconds against the iButton Reader **Fig. 19-C**.
  - Red LED OFF.
  - Operating data recording system active.

If the machine is **not** registered with the iButton, the following condition arises according to the selected option:

Access authorization	Display LED	Machine function
without limitation (50EC001)	Red LED ON	Fully functional
with lock (50EC002)	Red LED ON	Function of the working tools locked, transport possible



#### Note

A red illuminated LED is a request for activation of the operating data recording system via the iButton!

#### Ending operation

Switch off the machine using the key switch.

### 3.4.2 On-board dosing system (option)

The on-board dosing system is used for optimum dosing of the detergent.



#### Attention

Only use detergents suitable for automatic machines (foam retarded). We recommend use of our detergents and care agents specifically developed for the machines. These products meet the requirements of the German Detergent and Detergent Act (WRMG).

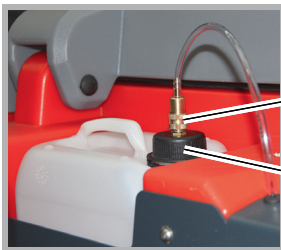

A

B

C

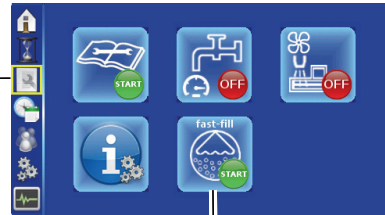

D

Fig. 20:

#### Putting into service

The following points must be run through for putting into service and after every canister change.

1. Release quick coupler **Fig. 20-A** at canister lid by pulling the lower ring of the coupling upwards. Unscrew lid from filled canister. Screw on lid with integrated hose **Fig. 20-B** and fit quick coupling with hose.
2. Turn the machine on with the key switch.
3. In the sub-menu *Maintenance* **Fig. 20-C**, select the *Fast-fill menu* **Fig. 20-D** with the turn-push knob and confirm.

When the program is started, the detergent is conveyed to the brush unit by means of the dosing pump. The program finishes automatically. The on-board dosing system is ready for operation.

### Setting the mixing ratio

In the action window, the mixing ratio of detergent/fresh water can be selected in 9 steps. Basic setting = 1:100

Mixing ratio	Detergent in the fresh water
1:700	0.1 %
1:500	0.2 %
1:300	0.3 %
1:200	0.5 %
1:150	0.7 %
<b>1:100</b>	<b>1.0 %</b>
1:75	1.3 %
1:50	2 %
1:20	5 %

Fig. 21:

1. Turn the machine on with the key switch
2. Select soft key *Dosing system* **Fig. 21-A** with the turn-push knob and confirm.
3. **Turn on:**  
Set the desired mixing ratio and confirm with the turn-push knob **Fig. 21-B**.  
The set mixing ratio is displayed with a green background **Fig. 21-C**.

**Change:**

Set the desired mixing ratio. The value is accepted automatically.

**Turn off:**

Push the turn-push knob.

### Maintenance

Check the piece of hose **Fig. 21-D** in the dosing pump and replace it after one year at the latest.

Replace the rotor **Fig. 21-E** after three years at the latest.

### 3.4.3 Useful cleaning tips

Sweep the floor before carrying out wet cleaning. This not only enhances the cleaning effect but also reduces wear of the machine's working tools.

If the floors are really dirty or wax needs to be removed, treat the floor twice.

In the first step, scrub the floor with a detergent suitable for the degree of soiling; the squeegee remains raised for this.

Leave the detergent for approx. 5 to 10 minutes; subsequently scrub the floor again and work with a lowered squeegee.

**Note**

- Only use detergents suitable for automatic machines (foam retarded). We recommend use of our detergents and care agents specifically developed for the machine. These products meet the requirements of the German Detergent and Cleaning Agent Act (WRMG).
- Observe correct dosing of the detergent. Correct dosing saves money and protects the environment. Strong foam formation is a sign of excessive dosing and impairs machine operation.

### 3.4.4 Handling and braking the vehicle



**Note**

Set the key switch to '0' to immediately disable all the functions.

**Danger**



- Danger of tilting over when driving on excessively steep slopes  
Transport journeys on slopes of up to 10 % must only take place for a limited period of time and with special caution.
- Risk of skidding when driving on wet surfaces.  
Drive very carefully into the bend when driving downhill.

Observe the following points when driving:

- Driving speed and braking of the machine are controlled via the accelerator pedal.
- The engine brake is automatically applied when the accelerator pedal is released. This also applies when ascending or descending.
- Stop the machine: Release the accelerator pedal. Operate the operating brake for maximum deceleration.
- When the machine is at standstill, the parking brake is activated audibly. It is no longer possible to push the machine, see section 3.4.5.

**Overload protection**

In case of an overload, e.g. excessively steep slopes, the drive motor is switched off after a certain period of time.

- Let the machine cool down for approx. 15 minutes.
- Restart the machine.



### 3.4.5 Pushing the machine



#### Danger

Risk of accident! When pushing the machine, it does not have any braking effect.

Only push the machine on a level surface!

After pushing the machine, do not re-start until the lever(s) has (have) been positioned and the cover has been fitted.

If the machine stops on an uphill or downhill gradient, call the towing service or Hako service!

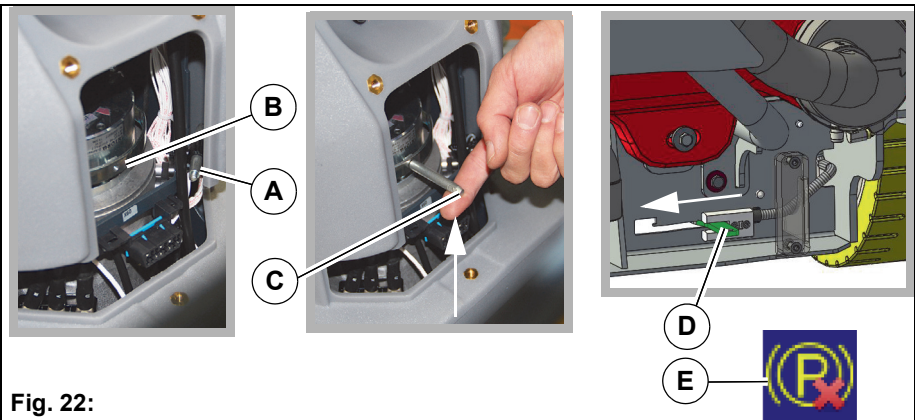

Fig. 22:

In order to push the machine, carry out the following steps:

1. Loosen the bolts of the cover to the drive using the supplied socket wrench and remove the cover.
2. Remove the pin **Fig. 22-A** from the holder and screw it into the ring **Fig. 22-B**.
3. In order to unlock the parking brake, pull the pin upwards slightly **Fig. 22-C** and simultaneously push the machine.

If the machine has an X-AC drive, the rear wheel brake must also be unlocked. To do so, push the lever at the rear on the right side of the machine **Fig. 22-D** from right to left until it engages.

Indication appears on the multifunction display when the rear wheel brake is taken out of service **Fig. 22-E**. The machine can no longer be driven!

Disassembly is in reverse order.

### 3.4.6 Turning off the machine

1. Slowly bring the accelerator pedal to the zero position. The machine slows down to standstill. A better braking effect is achieved when the machine is slowed down by applying the brake.
2. When the machine is at standstill, the parking brake is activated audibly.
3. Switch off the cleaning functions.
4. Switch off the machine using the key switch.



**Note**

Remove the key when leaving the machine to prevent unauthorised use.

### 3.4.7 Check list: after cleaning



**Environmental danger**

Observe the applicable laws and local regulations when disposing of detergents.



**Attention**

Do not use a high-pressure cleaner or steam cleaner to clean the machine.

	Description
1	Drive to a suitable maintenance location.
2	Switch the machine off and pull out the key.
3	Empty and clean the waste water tank, see section 5.4.2.
4	Check the fresh water filter, see section 5.4.6.
5	Check the sealing strips and suction hose, see chapter <i>Maintenance and Servicing</i> .
6	Check the functions and settings.
7	Charge the battery, see section 5.2.2.
8	Clean the machine. If the machine is not used over a longer period of time, the solution tank must be fully emptied.

### 3.5 Loading and transporting



#### Attention

- When loading and subsequently transporting the machine to the work site, the squeegee and brush head must be raised. Fresh and waste water tank must be empty!
- Risk of skidding! Drive very carefully and, if possible, only on dry ramps.
- To load the machine, reverse it up the ramp at idle speed (maximum slope 16 %).

#### Loading

When loading the machine, observe its weight, see Section 4 *Technical data*.

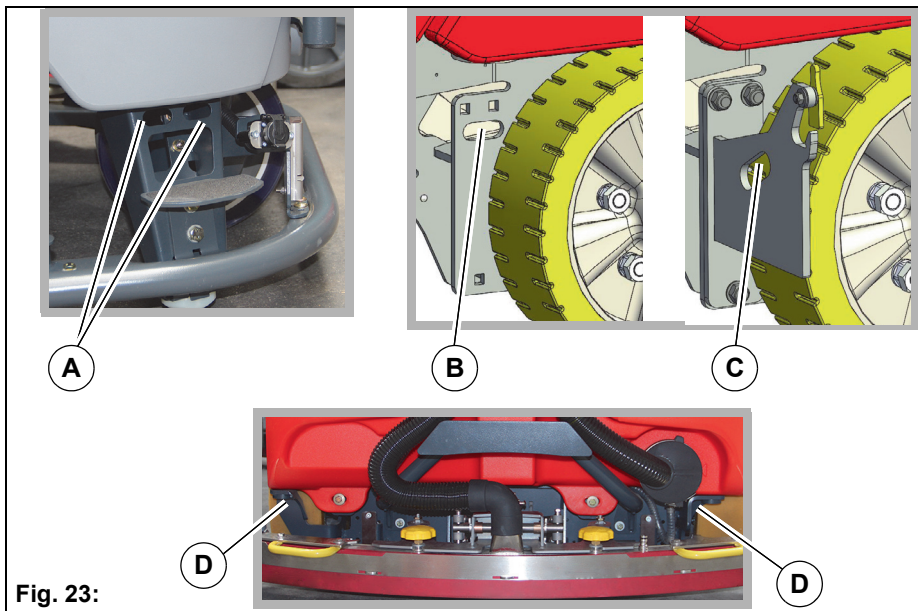

#### Transporting

When transported on a vehicle or trailer, the machine must be secured against tilting and rolling away. To do so, securely lash the machine on both sides at the front **Fig. 23-A**, at the side **Fig. 23-B** (without side collision protection), **Fig. 23-C** (with side collision protection) and at the rear **Fig. 23-D** with tension straps.

### 3.6 Service information

In case problems occur with the machine, a four-digit service code is output in the display panel in addition to the service indicator (tool key). The table below explains the most important service codes. Eliminate the cause or note down the service code and inform your authorised Hako service partner.

If the cause has been eliminated, the fault must be acknowledged via the key switch OFF/ON.

Service code	Fault	Cause	Remedy
1.2.5.1/ 1.2.5.2/ 1.2.5.5	Brushes stop	Foreign particles between brush and shaft	Inspect the brushes for foreign particles and remove them if necessary
1.2.6.1/ 1.2.6.8/ 1.2.6.2	Brushes stop	Foreign particles block the brush	Inspect the brushes for foreign particles and remove them if necessary
		Brush not positioned correctly in the holder	Actuate the brush decoupling system, contact the service partner if necessary
1.2.6.3	Brush lift system, brush and suction turbine have been switched off	Foreign particles between brush head and machine	Inspect the brush head for foreign particles and remove them if necessary
		Brush head stuck	Release brush head
1.4.6.1	Squeegee lift system stops	Overload due to foreign particles	Inspect for foreign particles and remove them if necessary
		Foreign particles between squeegee and machine	Inspect the lift system for foreign particles and remove them if necessary
		Squeegee jammed	Make the squeegee accessible
1.4.6.3/ 1.4.6.4	Suction turbine stops	Foreign particles in the suction turbine	Notify service partner
		Faulty suction turbine	
1.5.5.1	Fresh water level not displayed	Error in the electronics	Notify service partner
2.2.5.1	Rotating cylindrical brush stops	Foreign particles block the brush	Inspect the rotating cylindrical brush for foreign particles and remove them if necessary

Service code	Fault	Cause	Remedy
2.3.5.1/ 2.3.6.1/	Side brushes stop	Foreign particle blocks the side brushes	Inspect the side brushes for foreign particles and remove them if necessary
2.3.6.4	Side brush arm lift system stops	Overloading or foreign particles between side arm and machine	Inspect for foreign particles and remove them if necessary
3.1.6.E	Cleaning function no longer possible	Electrical defects	Notify service partner
3.2.6.6.	Service code indicator when turning on the machine	Discharged capacity of the internal back-up battery of the machine control	Notify service partner
3.3.1.1	Service interval expired		See maintenance plan
3.4.1.1	Speed control		Machine OFF/ON
3.4.1.2/ 3.4.1.4	Driving not possible	Error in the drive control	Machine OFF/ON, or notify service partner if necessary
3.4.5.1.	Cleaning function switches off	Drive wheel becomes sluggish due to foreign particles	Remove foreign particles
		Drive motor overheats	Let the engine cool down
3.6.6.4.	Driving and cleaning not possible	Seat permanently loaded	Relieve seat
4.2.1.4	Dosing system not working		Notify service partner
5.2.6.1	Faulty signal for charging state measurement	Cables on the battery poles loose or detached	Contact the customer service
		Incorrect type of battery installed	Install correct battery
7.1.5.1	USB connection not working	Connected consumer overloaded	Check whether the consumer is drawing too much power or there is a short-circuit in the connected cable.
		Internal controller defect	Notify service partner

## 4 Technical data

### Dimensions

Name	Unit	
Length of machine with squeegee without/with pre-sweep unit	mm	2020/2790
Width of machine without/with squeegee: with rotating brush 1080 with rotating brush 1230 with roller brush 1080	mm	1150/1290 1290/1290 1210/1290
Height of machine without/with overhead guard	mm	1490/2090

### Working width

Brush unit: Rotating brush 1080 Rotating brush 1230 Roller brush 1080	mm	1080 1230 1080
Squeegee	mm	1260

### Weights

Weight (empty, without batteries): Front-wheel drive with 2-rotating brush unit 1080 Front-wheel drive with 3-rotating brush unit 1230 Front-wheel drive with roller brush unit and side brush X-AC drive with 3-rotating brush unit 1080	kg	535 560 595 610
Total weight (ready for use): Front-wheel drive with 2-rotating brush unit 1080 Front-wheel drive with 3-rotating brush unit 1230 Front-wheel drive with roller brush unit and side brush X-AC drive with 3-rotating brush unit 1080	kg	1350 1375 1410 1425
Permissible total weight (incl. pre-sweep suction unit)	kg	1780

## Driving performance

Name	Unit	
Driving speed transportation (forwards/reverse)	km/h	8/4
Climbing capacity when cleaning: Front-wheel drive X-AC drive	%	6 (2 min.) 15 (up to 5 min. at 4 km/h)
Climbing capacity during transport journey (ready for operation): Front-wheel drive X-AC drive	%	10 (1 min.) 18 (3 min at 4 km/h)
Ramp angle/Slope angle	%	16
Turning circle in gear without/with pre-sweep suction unit: with rotating brush unit 1080 with rotating brush unit 1230 with roller brush unit 1080	mm	2150/2890 2210/2940 2170/2900

## Wheels

Wheel diameter front/rear	mm	305/350
Specific wheel contact front/rear (ready for operation with driver): Front-wheel drive X-AC drive	N/mm <sup>2</sup>	0.83/0.68 1.12/0.6

## Tank contents

Solution tank	Litre	260
Waste water tank	Litre	260

## Brush units

Brush speed rotating brush/roller brush:	rpm	210/640
Brush contact pressure normal/stage1/stage2 2-rotating brush unit 1080 3-rotating brush unit 1080 3-rotating brush unit 1230 Roller brush unit 1080	kg	40/55/70 58/73/88 68/83/98 25/40/55

## Vacuum system

Name	Unit	
Air quantity suction turbines	m <sup>3</sup> /h	approx. 200
Vacuum (maximum)	mbar	approx. 170

## Electrical system

Nominal voltage	V	36
Nominal output (max.) (P1): Front-wheel drive with 2-rotating brush unit 1080 Front-wheel drive with 3-rotating brush unit 1080 or 1230 Front-wheel drive with roller brush unit and side brush X-AC drive with 3-rotating brush unit 1080	W	5668 6604 6763 9296
Power consumption drive motor (P1): Front-wheel drive X-AC drive front/rear	W	2335 2335/2692
Power consumption of vacuum motor (P1) suction turbines	W	1282
Power consumption brush motor (P1) 2-rotating brush unit 1080 3-rotating brush unit 1080 or 1230 Roller brush unit 1080 Side brush unit 1280	W	2x936 3x936 2x1368 2x115
Power consumption water pump (P1)	W	approx. 67
Type of protection		IPX 3
Protection class		III

## Pre-sweep suction unit

Name	Unit	
Machine length	mm	800
Height of machine	mm	660
Machine width (above swivel bracket)	mm	1220
Working width	mm	1300
Cylindrical brush width	mm	670
Cylindrical brush, minimum diameter	mm	200
Cylindrical brush speed	rpm	500



Name	Unit	
Sweeping level width	mm	45±10
Side brush diameter	mm	400
Side brush speed	rpm	92
Theoretical sweeping capacity	m <sup>2</sup> /h	10400
Dirt hopper volume (maximum load 20 kg)	Litres	16
Filter area	m <sup>2</sup>	1.4
Filter use category ZH 1/487	KAT	U
Drive motor (P1)	W	756
Nominal voltage	V	36
Permissible total weight	kg	115

### Noise emission value

		B260 R rotating brush unit		B260 R roller brush unit	
		Standard operation	Silent operation	Standard operation	Silent operation
The sound power level ( $L_{WA,d}$ ) measured under the customary conditions of use according to DIN EN 60335-2-72 is:	dB (A)	86	82	89	86
The sound pressure level ( $L_{pA}$ ) (at the ear of the driver) measured under the customary conditions of use according to DIN EN 60335-2-72 is:	dB (A)	69	65	71	67
Measuring uncertainty ( $K_{pA}$ )	dB (A)	1.0	1.0	2.0	2.0

### Vibration

Under the customary conditions of use, the weighted effective value of the acceleration to which the upper limbs (hand-arm) are subjected to according to DIN EN ISO 5349 is:	m/s <sup>2</sup>	≤ 2.5
Under the customary conditions of use, the weighted effective value of the acceleration to which the body (feet or seat surface) is subjected to DIN EN ISO 2631-1 is:	m/s <sup>2</sup>	≤ 0.5

## 5 Maintenance and Servicing

### General

The operator is instructed fully on delivery of the machine.



#### Attention

Before undertaking servicing and maintenance work, read and observe the safety instructions in chapter 1 of this operating manual!

Compliance with the maintenance work recommended by us gives you the certainty of always having an operational machine available.

Daily and weekly maintenance and repair work can be undertaken by a driver trained for this purpose. For all other maintenance work, see service booklet, please contact your nearest Hako service centre or authorised Hako dealer. Any warranty claim is null and void if this is not complied with and damage results.

Please always state the serial number in all enquiries and spare parts orders, see section 1.7 - type plate.



#### Note

- Maintenance parts in the machine are marked with a yellow dot and yellow areas.
- The maintenance instructions can also be called up on the multi-function display in the form of pictures, see section 2.3.3 *Maintenance menu*.

### 5.1 Maintenance plan

#### Hako system maintenance customer:

Work to be performed by the customer by reference to the servicing and maintenance instructions specified in the operating manual.

#### Daily

- Emptying the waste water tank
- Clean the waste water tank, drain hose, coarse dirt sieve and suction filter
- Check the cover seal of the waste water tank, clean if necessary
- Check the battery, charge if necessary
- Check the squeegee, clean if necessary
- Emptying the dirt hopper in the roller brush unit (optional)
- Check all brushes for foreign particles and clean if necessary

<ul style="list-style-type: none"> <li>• X-AC drive: Check the position of the lever for unlocking the parking brake. The lever must be in the normal position (right), see <b>Fig. 22-D</b></li> </ul>
<p>Pre-sweep suction unit (optional):</p> <ul style="list-style-type: none"> <li>• Clean the cylindrical brush compartment</li> <li>• Clean the plate filter using the shaking system</li> <li>• Empty the dirt hopper</li> </ul>
<p><b>Weekly</b></p>
<ul style="list-style-type: none"> <li>• Clean the machine as required</li> </ul>
<ul style="list-style-type: none"> <li>• Clean the solution tank</li> </ul>
<ul style="list-style-type: none"> <li>• Check the sieve insert in the fresh water filter, clean or replace if necessary</li> </ul>
<ul style="list-style-type: none"> <li>• Check the scrubbing performance of the brushes/pads, clean if necessary</li> </ul>
<ul style="list-style-type: none"> <li>• Check the brushes and water retaining ring for proper fit and wear, replace if necessary</li> </ul>
<ul style="list-style-type: none"> <li>• Check the suction performance of the squeegee, clean or replace the sealing strips if necessary</li> </ul>
<ul style="list-style-type: none"> <li>• Check the fresh water supply to the brushes, clean if necessary</li> </ul>
<ul style="list-style-type: none"> <li>• Check the suction hose for tight fit and damage, clean if necessary</li> </ul>
<ul style="list-style-type: none"> <li>• Check the rubber of the lateral wiper, replace if necessary</li> </ul>
<ul style="list-style-type: none"> <li>• Batteries with Aquamatic system: Checking the acid level</li> </ul>
<ul style="list-style-type: none"> <li>• Pre-sweep suction unit (optional), check cylindrical brush, clean if necessary</li> </ul>
<ul style="list-style-type: none"> <li>• On-board dosing system (optional): Check section of hose in the dosing pump, replace if necessary</li> </ul>
<ul style="list-style-type: none"> <li>• Trial run and function test</li> </ul>

## 5.2 Battery

### 5.2.1 Checking the charging state



Fig. 24:

The charge condition of the battery **Fig. 24-A** is displayed on the multifunction display during operation. Depending on the charge condition, the following symbols appear:

Symbols	Charging state	Notes
	Battery is fully charged	
to	Battery capacity is displayed in steps of 10 %	Battery can be charged $\leq 60$ %
	Battery capacity less than 10 %	Cleaning functions are switched off after 3 minutes. Charge the battery!
	Battery is empty	Cleaning functions will be switched off. Only travel at half speed is possible. Battery must be fully charged immediately!
	BMS service information. A four-digit service code appears at the same time <b>Fig. 24-B</b>	Service information, see section 3.6.

## 5.2.2 Charge the battery



### Warning

Risk of explosion! Explosive gases can develop when charging the battery.

- Avoid smoking and naked flames in the vicinity of batteries.
- Swivel up the seat console all the way before charging the battery.  
The seat console must remain open when charging the battery!
- Ensure that there is sufficient ventilation when charging the battery.
- Only connect and disconnect the battery plug when the charger and the machine are turned off!
- Do not place the battery plug on the battery during charging!
- Never place tools or other electrically conductive objects on the battery!

### Attention

- Before initially starting up the machine, the battery that is used must be fully and properly charged with commissioning charge. Please observe the instruction manual of the charging device and the instruction manual of the battery manufacturer. Hako assumes no liability for battery damage resulting from insufficient commissioning charge.
- Never leave batteries discharged, always recharge them immediately.
- If possible, charge the batteries fully to ensure that the batteries have an optimum service life. The charger is designed as a continuous charger and retains the charging state of the battery (trickle charge) after completing the charging process.
- The battery should always be charged without being interrupted.
- During the charging process it is not possible to turn on the machine.
- Observe the information in the instruction manual of the charger and of the battery manufacturer!

### Charging the battery with a stationary charger

Charge the batteries with a stationary charger as, for example, shown in **Fig. 25-A**. The batteries can be charged if the battery capacity is less than 60 %.



#### Note

For safe charging, the Hako charger and the battery have a safety circuit (pilot contact control unit).

The charger (99400110) can only charge batteries that have the PCCU circuit **Fig. 25-B**.

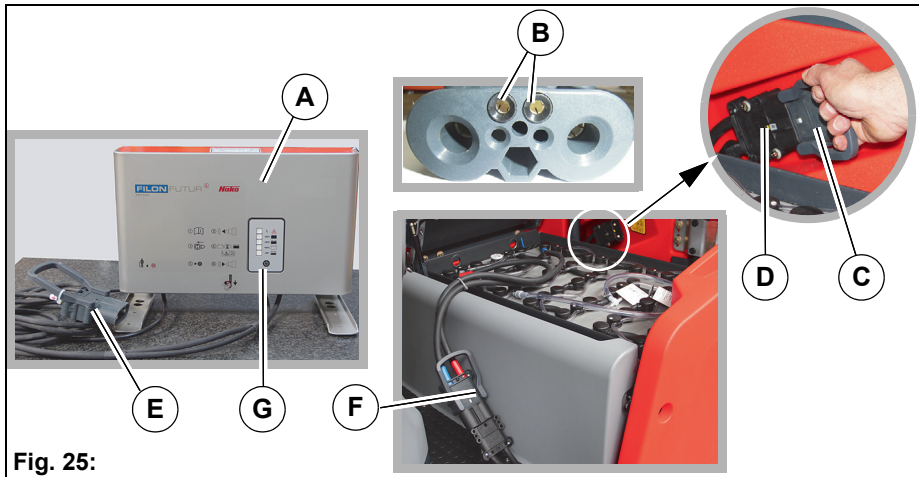

**Fig. 25:**

1. Place the machine on a level surface and turn it off.
2. Open the seat console and leave it open during loading!
3. Remove the battery plug **Fig. 25-C** from the plug of the machine **Fig. 25-D**.
4. Connect the battery plug to the plug of the charger **Fig. 25-E** and position it in front of the battery trough **Fig. 25-F**.
5. Switch on the charger.
6. The progress of the charging process is displayed in the display **Fig. 25-G** of the charger.
7. Once the battery is fully charged, terminate the charging process:
  - Turn off the charger and wait approx. 15 minutes with the seat console open.
  - Disconnect the battery plug from the plug of the charger and reconnect it to the plug of the machine **Fig. 25-D**.

### 5.2.3 Checking the acid level

The customer must check the acid level of the batteries once a week.



#### Warning

Risk of explosion and fire! When handling batteries, it is prohibited to smoke and use an open fire.

#### Attention

- Observe the information in the operating manual of the battery manufacturer!
- Refilling must only take place once the battery charging process has been terminated.



#### Note

Batteries approved by Hako are equipped with an aquamatic system.

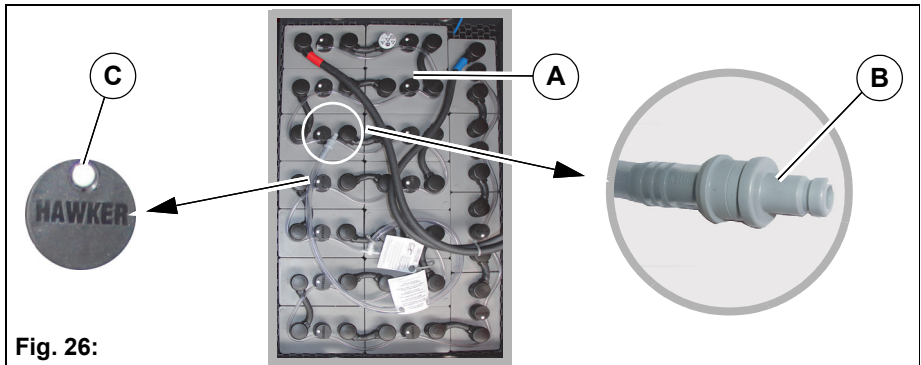

Fig. 26:

#### Checking the acid level:

If the trough battery is equipped with an aquamatic system **Fig. 26-A**, each individual cell features a sealing plug with float indicator.

The white dot must be located at the top and must be clearly visible. If this is not the case, refill demineralised water according to DIN 43530-4.

#### Topping up with demineralised water:

Connect the end piece of the aquamatic system **Fig. 26-B** to a container with demineralised water. Observe sufficient gradient, ensuring the water can flow into the cells. Once the required filling level has been reached, the plugs automatically seal the cells and indicate “full” **Fig. 26-C**.

## 5.2.4 Replacing the battery



### Attention

- Only use batteries approved by Hako at the intended position!
- The battery should only be replaced by qualified service personnel!
- Wear safety shoes when changing the battery.
- Only change the battery using suitable lifting gear and crane gear with a sufficient load-bearing capacity.
- Lifting hooks may not cause damage to cells, connectors or connecting cables!
- When using other batteries which have been approved by Hako, the BMS must be reset to protect the battery against total discharge. The settings of the BMS must only be carried out by a workshop authorised by Hako!

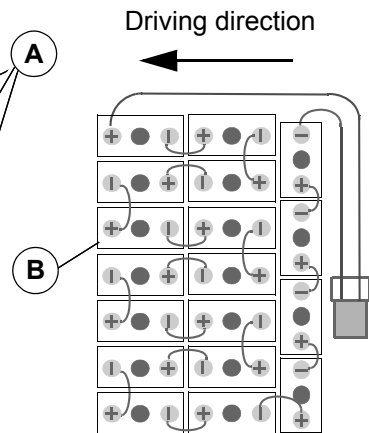

Fig. 27:

### Removing the battery

1. Place the machine on a level surface and turn it off.
2. Undo the side panelling of the machine with the provided spanner and remove.
3. Open the seat console all the way.
4. Disconnect the battery plug.
5. Hook crane gear into the eyelets of the battery trough **Fig. 27-B**.  
The crane gear must carry out a vertical pull so that the battery trough is not distorted.



6. Slowly lift the battery trough upwards and swivel out to the side. Assembly is in reverse order.



**Note**

Please ensure that the trough battery is in the correct installation position! See connecting diagram **Fig. 27-B**.

### 5.2.5 Battery plug coding

When using other batteries which have been approved by Hako, the plugs must be re-coded.

The plug connectors between the battery **Fig. 28-A**, the machine **Fig. 28-B** and the charger **Fig. 28-C** are coded with coloured coded pins (yellow, grey or green) **Fig. 28-D** depending on the type of battery and rated voltage.

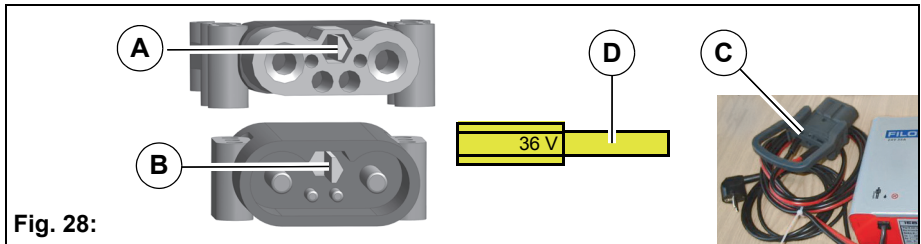

**Fig. 28:**

The following three prerequisites must be met for the whole system:

- Voltage coding (36 V) must be identical for all plugs and bushes.
- The colour of the coded pin in the connector housing of the machine is always yellow.
- The colour of the coded pin in the charger plug (machines without built-in charger) and in the bush housing of the battery must be identical:
  - Grey for wet batteries
  - Green for maintenance-free gel batteries



**Warning**

Risk of short circuit! The coding of the plugs should only be carried out by a workshop authorised by Hako!

### **5.2.6 Maintaining drive batteries**

For maintaining and servicing drive batteries, see Hako supplementary sheet 88-60-2556 – *Information for drive batteries* and the operating manual of the battery manufacturer.

### **5.2.7 Taking the machine out of service for a long period**

If the battery is not used for more than three months, the battery must be recharged.



**Note**

Only park unused machines if they are switched off, have a fully charged battery and are placed in a dry location.

### **5.2.8 Disposing of batteries**

Used batteries with the recycling symbol contain reusable commodities. They must not be disposed of in domestic waste, see Section 1 *Environmental protection instructions and disposal*.

### 5.3 Solution tank

The filling level in the solution tank is measured continuously and shown in the multifunction display in steps of 20 %. If there are less than 10 litres in the tank, a warning symbol **Fig. 29-A** appears in the multifunction display. At the same time, an acoustic warning is heard and indicates that a top-up is required.

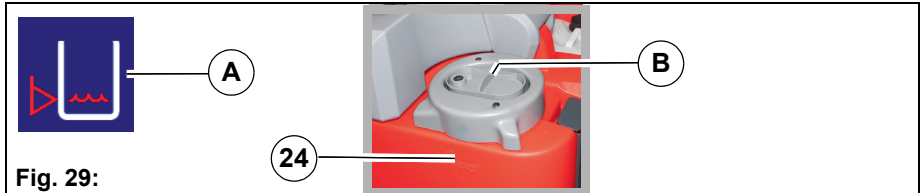

Fig. 29:

#### 5.3.1 Filling the solution tank

Fill the solution tank **Fig. 29-24** through the filling opening before commencing work or as required **Fig. 29-B**.



#### Attention

In order to avoid contamination of the drinking water by backflow, the requirements of DIN EN1717 must be adhered to for filling the solution tank.

#### Filling the solution tank with a hose

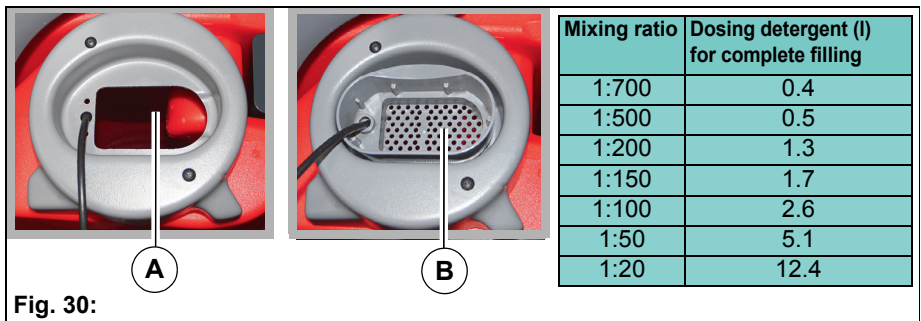
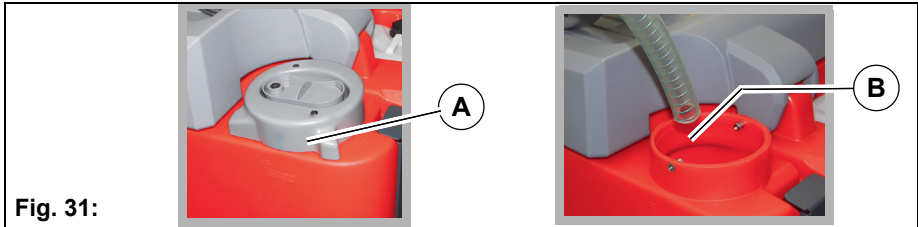

Fig. 30:

1. Place the machine on a level surface.
2. Remove insert in grey cover **Fig. 30-A**.
3. Fill the solution tank three-quarters full (maximum water temperature 50 °C).
4. Add detergent according to the manufacturer's regulations via the sieve insert **Fig. 30-B** (observe table above).
5. Fill the solution tank with fresh water up to the maximum filling level.

### Filling the solution tank with the fast fill station

The filling opening of the solution tank can be increased when filling with the fast fill station by unscrewing the grey cover **Fig. 31-A** and removing it **Fig. 31-B**.



### Filling the solution tank with the automatic filling unit

Optionally, the solution tank can be filled via the automatic filling unit.

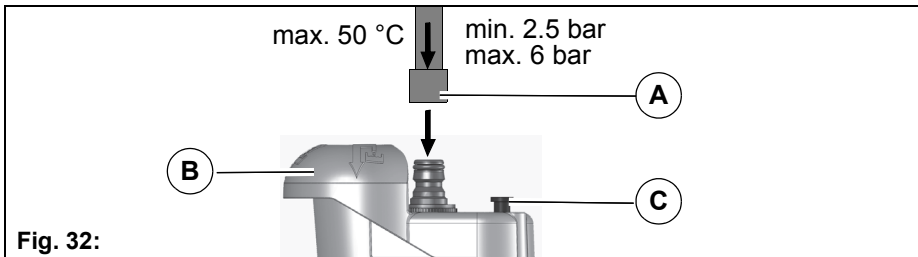

1. Fit the hose with the quick coupler **Fig. 32-A**. Do not yet open the water supply!
2. Push the operating button **Fig. 32-B**. The indicator knob **Fig. 32-C** protrudes.
3. Open the water supply – water starts to flow.
4. The filling unit switches off automatically when the tank is full. The indicator knob **Fig. 32-C** no longer protrudes.
5. Close the water supply and remove the hose with the quick coupling.  
Use a water line fitted with a stop valve!



#### Note

The machine can also be filled manually through the opening in the operating button **Fig. 32-B**.

### 5.3.2 Emptying the solution tank

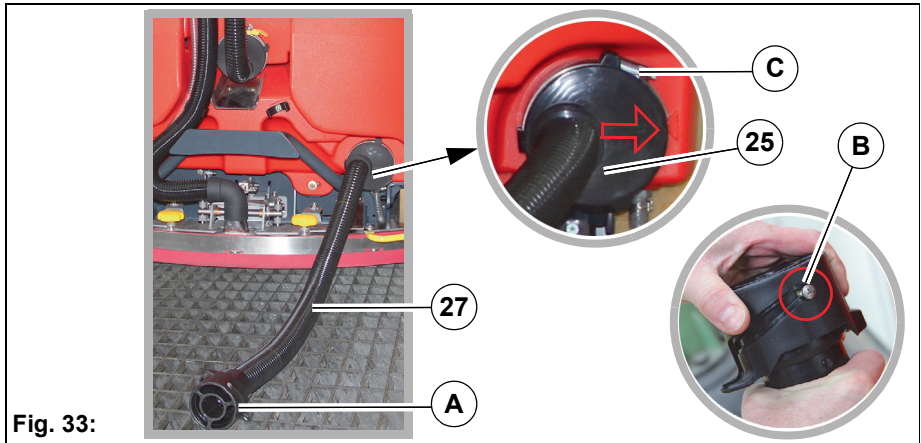

**Fig. 33:**

1. Drive to a suitable disposal centre.
2. Position the machine, ensuring the drain hose **Fig. 33-27** reaches the drain in the ground.
3. Turn off the machine.
4. Remove the drain hose from the holder, open the drain valve **Fig. 33-A** and drain the waste water tank via the drain.
5. Ensure that the drain hose closure is fully closed after draining **Fig. 33-B!**

### 5.3.3 Cleaning the solution tank

1. Empty the solution tank, see section 5.3.2.
2. Undo the screw clamp **Fig. 33-C** with a screwdriver and remove the drain hose **Fig. 33-27**.
3. Lead the water hose through the maintenance opening **Fig. 33-25** and clean the solution tank thoroughly.
4. Position the drain hose onto the support of the maintenance opening (arrow must point to the right) and close again securely using the screw clamp.

## 5.4 Waste water tank

### 5.4.1 Emptying the waste water tank

Clean the waste water tank **Fig. 35-37** daily or as required. When the symbol *Waste water tank full* **Fig. 34-A** appears in the display panel and an acoustic warning signal is output, the suction functions are switched off and the waste water tank should be drained immediately.



#### Environmental danger

Observe applicable laws and local regulations when disposing of detergents!

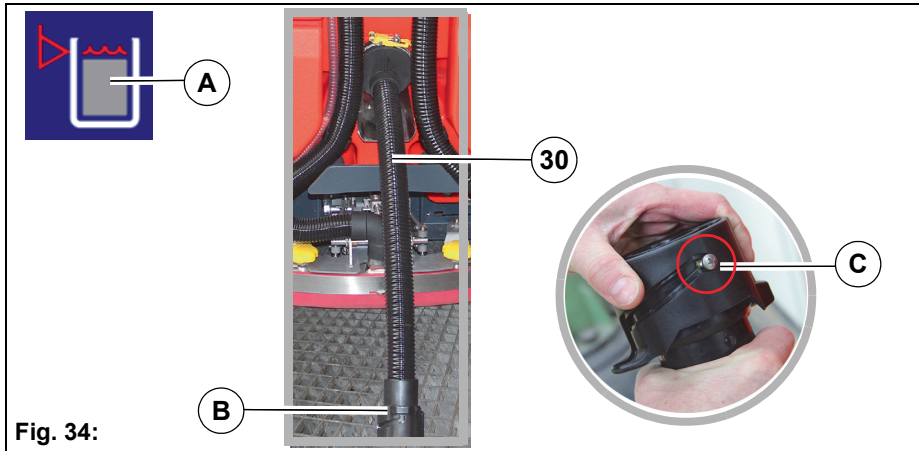
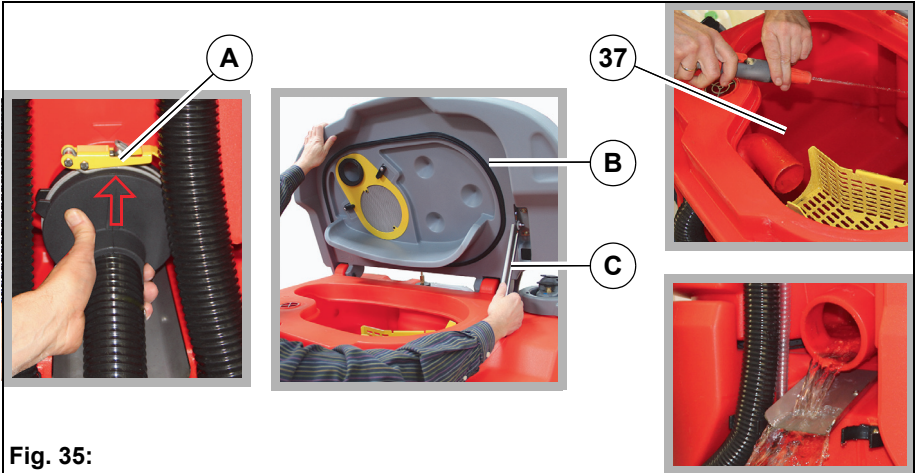

Fig. 34:

1. Drive to a suitable disposal centre.
2. Position the machine, ensuring the drain hose **Fig. 34-30** reaches the drain in the ground.
3. Turn off the machine.
4. Remove the drain hose from the holder, open the drain valve **Fig. 34-B** and drain the waste water tank via the drain.
5. Ensure that the drain hose closure is fully closed after draining **Fig. 34-C!**

### 5.4.2 Cleaning the waste water tank

Clean the waste water tank daily or as required.

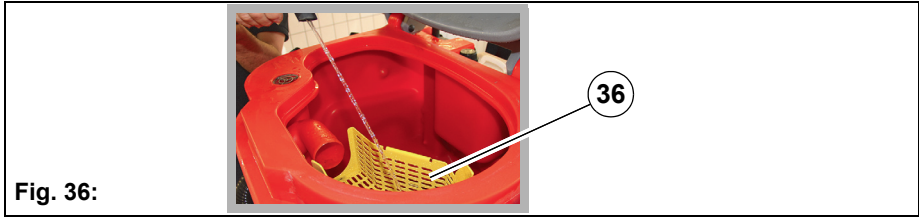

**Fig. 35:**

1. Empty the waste water tank, see section 5.4.1.
2. Open fastener at drain hose **Fig. 35-A** and remove hose.
3. Open the tank cap **Fig. 35-B** of the waste water tank.
  - Reach into the recessed grip of the tank cap with one hand.
  - Open the tank cap until the support **Fig. 35-C** engages.
4. Clean the waste water tank thoroughly with the water hose/spray nozzle **Fig. 35-D**.
5. Also flush the drain hose.
6. Close the tank cap:
  - Reach into the recessed grip with one hand and open the tank cap a little further.
  - Release the support **Fig. 35-B** with your right hand and close the tank cap.
7. Position the drain hose on the neck of the maintenance opening (arrow must point upwards) and securely close using the fastener.

### 5.4.3 Cleaning the coarse dirt sieve

A coarse dirt sieve **Fig. 36-36** is optionally located in the waste water tank. Clean the sieve daily and as required.



### 5.4.4 Cleaning the intake sieve

Check the function of the intake sieve **Fig. 37-38** daily and clean it as required.

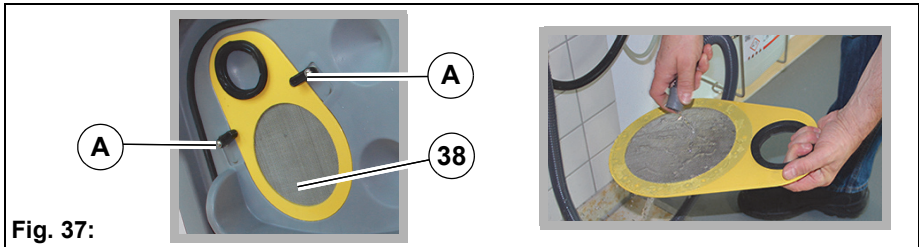

1. Rotate the locks **Fig. 37-A** downwards and remove the intake sieve **Fig. 37-38**.
2. Thoroughly clean the intake sieve under running water.

### 5.4.5 Checking the seal at the drain valve

Check the function of the seal in the drain valve **Fig. 38-A** daily, and replace it after no more than 125 operating hours.

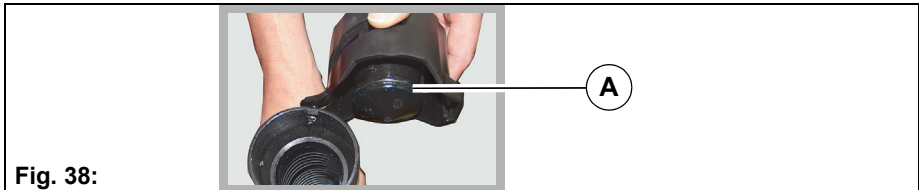

1. Twist drain valve by 90° and swivel down from drain hose.
2. Change the seal.
3. Grease seal and cone with Molykote.



### 5.4.6 Cleaning the fresh water filter

Check the filter sieve **Fig. 39-A** of the fresh water filter **Fig. 39-12** weekly and clean or replace it as required.

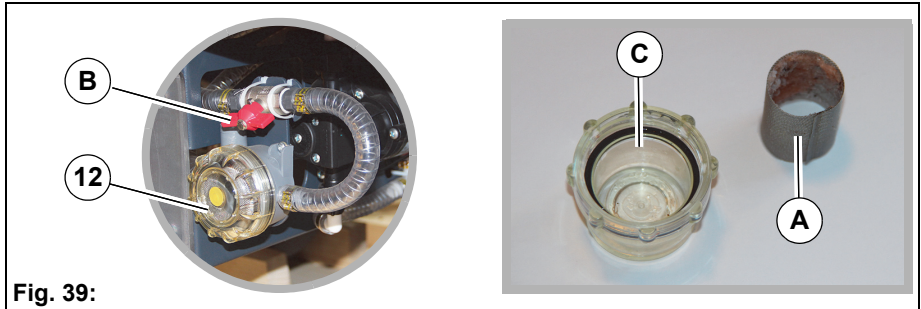

**Fig. 39:**

1. Close the ball cock **Fig. 39-B**.
2. Turn and remove the filter cover **Fig. 39-C**.
3. Remove the filter sieve **Fig. 39-A** from the filter housing and clean it under running water. Replace the filter sieve as required.
4. Reinsert the filter sieve and filter cover and open the ball cock.

### 5.4.7 Checking the seal in the tank cap

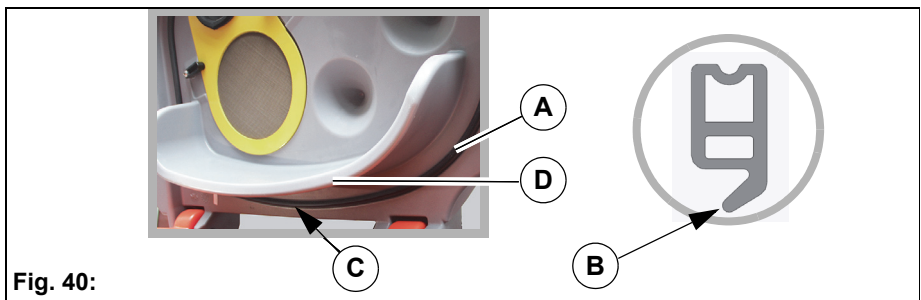

**Fig. 40:**

Check the function of the seal in the tank cap **Fig. 40-A** daily and replace it if damaged.

When replacing the seal:

- pay attention to correct installation position – sealing lip **Fig. 40-B** must be facing outwards,
- ensure that the disconnection point of the seal finishes edge to edge – the disconnection point **Fig. 40-C** must be below the dripping edge of the cover **Fig. 40-D**,
- ensure that the seal is pressed fully into the groove.

## 5.5 Rotating brush unit

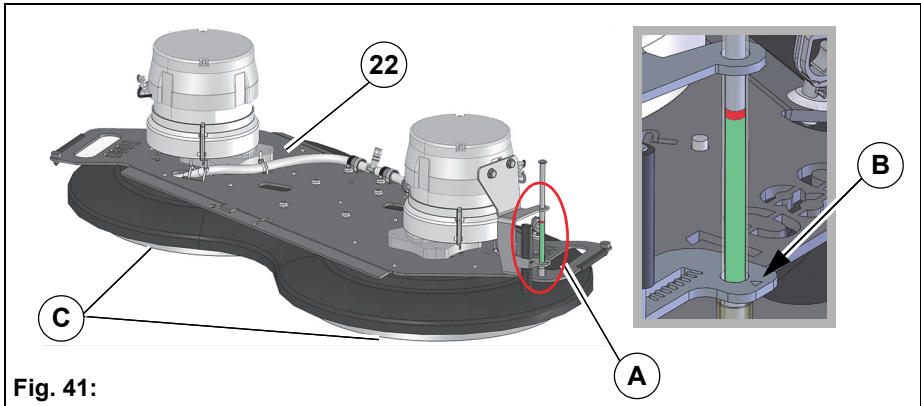

Fig. 41:

### 5.5.1 Replacing the brushes/pads

Use the indicator **Fig. 41-A** on the rotating brush unit to:

- determine the wear of the brushes/pads (the rotating brush unit must be lowered),
- determine whether the brushes/pads have been assembled.

The brushes/pads must be changed when the pointer **Fig. 41-B** is in the red zone at the latest.

1. Ejecting the brushes/pads, see section 5.5.3.
2. Inserting new brushes/pads, see section 5.5.4.



#### Attention

If no brushes/pads are fitted, the top edge of the display plate is outside the coloured area.

### 5.5.2 Cleaning the brushes

Clean the brushes **Fig. 41-C** in the rotating brush unit **Fig. 41-22** daily or as required.

1. Ejecting the brushes, see section 5.5.3.
2. Thoroughly clean the brushes under running water.
3. Coupling the brushes, see section 5.5.4.

### 5.5.3 Ejecting the brushes/pads

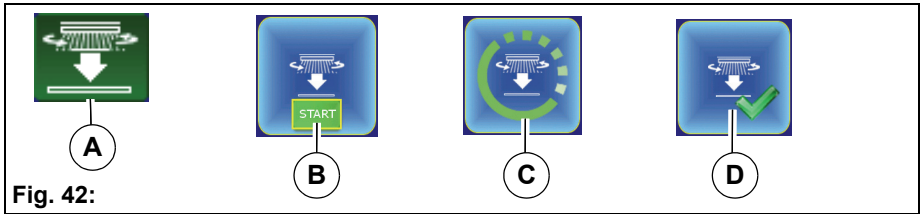

Fig. 42:

1. Make sure that the rotating brush unit has been raised and the machine is stationary.
2. Select soft key *Eject brushes* **Fig. 42-A** using the turn-push knob and confirm. The action window **Fig. 42-B** opens. Use the turn-push knob to confirm the start.  
The procedure starts and symbols **Fig. 42-C, D** appear on the multifunction display one after the other. Only now is the procedure complete.
3. Open the wiper, see section 5.8.1 and remove the brushes/pads.

### 5.5.4 Coupling the brushes/pads

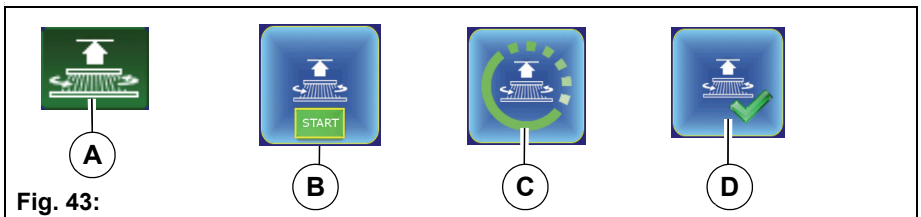
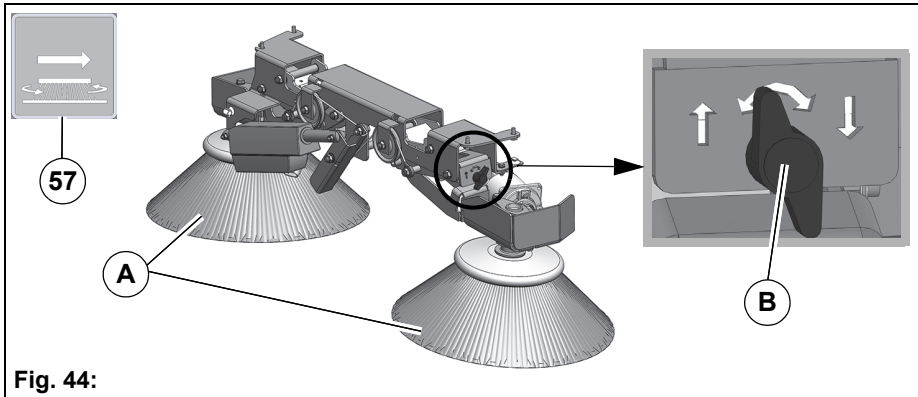

Fig. 43:

1. Make sure that the rotating brush unit has been raised and the machine is stationary.
2. Open the wiper and place the brushes/pads in a central position underneath the brush head holder.
3. Select soft key *Couple brushes* **Fig. 43-A** using the turn-push knob and confirm. The action window **Fig. 43-B** opens. Use the turn-push knob to confirm the start.  
The procedure starts and symbols **Fig. 43-C, D** appear on the multifunction display one after the other. Only now is the procedure complete.
4. Check whether the brushes have been coupled.
5. Close the wiper.

## 5.6 Side brush unit (optional)



### 5.6.1 Adjusting the side brush

#### Side brush tilt

The tilt of the side brush **Fig. 44-A** is preset in the factory and cannot be changed.

#### Readjusting the side brush position

Check side brush weekly for wear. In the event of wear or after changing the side brush, adjust as follows:

1. Place the machine on a level surface.
2. Lower the side brush unit with key *Side brush unit Fig. 44-57*.
3. Turn wing nuts **Fig. 44-B** clockwise at both sides until 1/3 of the area of the side brush is touching the floor.

## 5.6.2 Changing the side brush

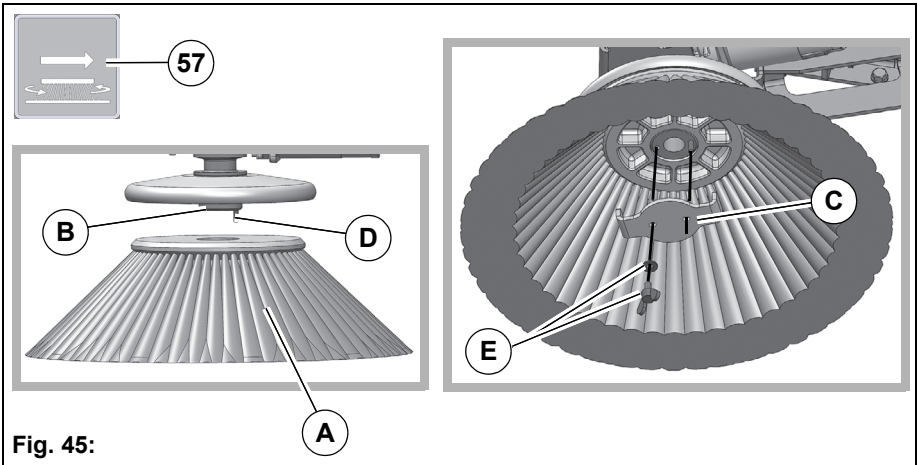

Fig. 45:

### Assembling the side brush

1. Place the machine on a level surface.
  2. Raise the side brush unit with key *Side brush unit Fig. 44-57*.
  3. Fit the side brush **Fig. 45-A** to the hub **Fig. 45-B**.
  4. Position the carrier plate **Fig. 45-C** in such a way that the pin of the hub **Fig. 45-D** goes through the hole of the carrier plate and the carrier plate is sitting firmly in the holder.
  5. Secure carrier plate to hub with washer and wing bolt **Fig. 45-E**.
- The side brush is dismantled in the reverse order.

## 5.7 Squeegee

Optimum vacuuming is achieved through:

- clean and undamaged or not worn sealing strips
- correctly set inclination angle and correct height adjustment of the sealing strips.

### 5.7.1 Cleaning the squeegee

Check the squeegee **Fig. 47-28** daily for soiling and foreign particles and clean it as required.



**Fig. 46:**

### Daily cleaning in the event of heavy soiling

1. Drive machine to a suitable location with drain in floor.
2. Switch off machine and ensure that the squeegee is in the raised position.
3. Pull off the suction hose **Fig. 47-E**.
4. Fold over the squeegee:  
Get hold of handles **Fig. 46-A** with both hands. Pull squeegee vertically upwards with a jerk until the flap mechanism activates. Then fold over by 90° as far as possible **Fig. 46-B**.
5. Remove coarse dirt and clean squeegee thoroughly using the hose.
6. Move squeegee to starting position:  
Move handles against the direction of travel until the flap mechanism is activated. Then fold over squeegee to starting position.

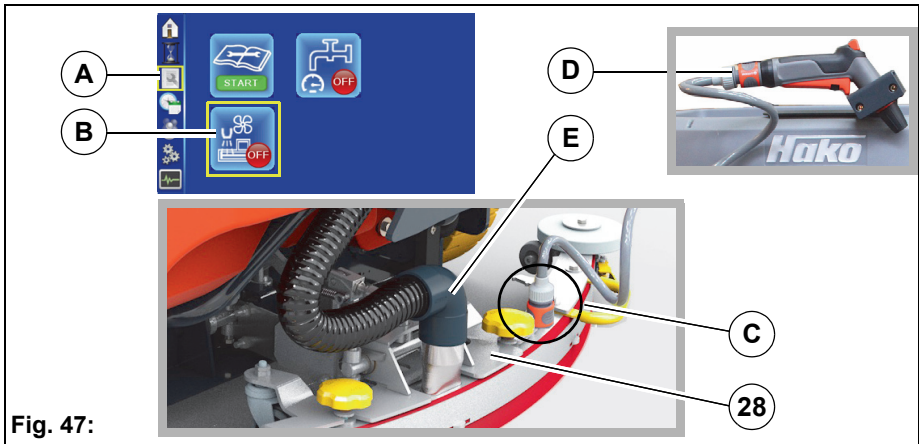

Fig. 47:

### Daily cleaning in the event of light soiling

#### External water connection:

1. Sit on the seat of the machine and switch on the machine.
2. In the sub-menu, call up menu item *Maintenance page Fig. 47-A*. Select soft key *Squeegee cleaning Fig. 47-B* with the turn-push knob and activate. The squeegee is lowered and the suction is switched on. The remaining squeegee cleaning time is displayed in 5 second intervals.
3. Move the machine forward a little so that the sealing lips are tilted back.
4. Connect hose to the connection of the squeegee **Fig. 47-C** using the 1/2" quick coupling, and to the water tap of the service connection.
5. Open the water tap all the way.  
Squeegee is cleaned by the internal spray nozzles.
6. After the program has ended, close the water tap and remove the hose.

#### On-board water connection:

Follow point 1-3 of section *External water connection*.

4. Disconnect hose from the spray nozzle **Fig. 47-D** and attach to the squeegee connection **Fig. 47-C**.
5. The squeegee is cleaned by the internal nozzles.
6. After the program has ended, remove the hose from the squeegee during the after-run time of the suction turbine and reconnect to the spray nozzle.



#### Attention

If the hose is not disconnected from the squeegee after the program has ended, the water may run out of the solution tank!

### 5.7.2 Changing the sealing / slot strip

Check the sealing strip **Fig. 48-A** and the slot strip **Fig. 48-B** at the squeegee weekly for wear and damage. If the used sealing edge of the strip is worn or damaged, turn or replace the strip. Each strip can be used four times before it needs replacing.

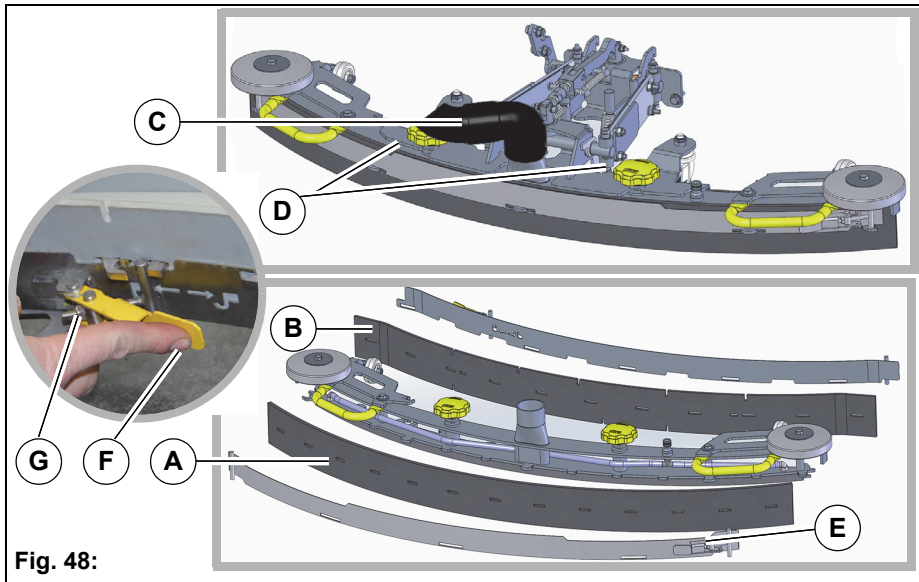

Fig. 48:

1. Pull off the suction hose **Fig. 48-C**.
2. Loosen the star-shaped handles **Fig. 48-D** and remove the squeegee.
3. **Replacing the sealing strip:**  
Release the tension strap **Fig. 48-E** and remove.  
**Replacing the slot strip:**  
Fold over the turnbuckle **Fig. 48-F** all the way when releasing so that the tension strap is easier to remove.
4. Remove strip from squeegee body.
5. Before turning or replacing the strips, thoroughly clean the squeegee body!  
Assembly is in reverse order.



**Note**

The strips can be of different thickness. The turnbuckles must be readjusted if necessary **Fig. 48-G**.



### 5.7.3 Adjusting the sealing strips

#### Inclination adjustment

The correct inclination adjustment is decisive for:

- ensuring that the sealing strips of the squeegee rest evenly with the complete contact surface on the ground.
- ensuring that the squeegee runs smoothly and evenly during the suction process.

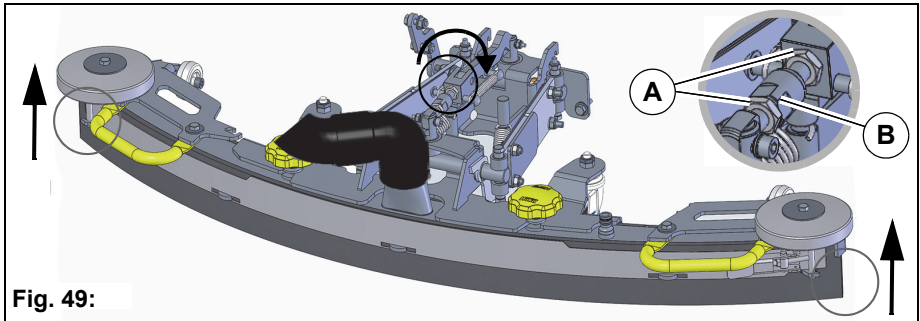

Fig. 49:

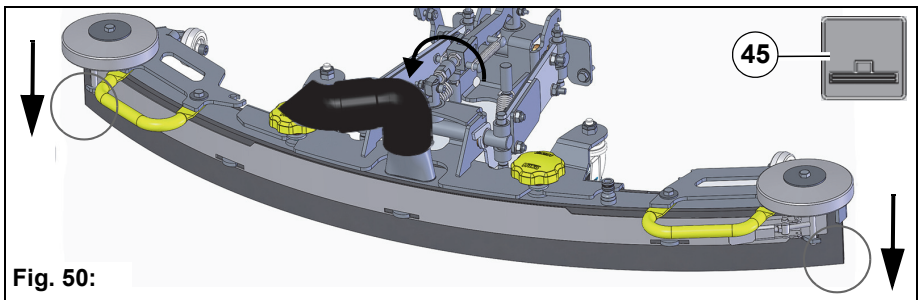

Fig. 50:

1. Place the machine on a level surface and lower the squeegee with the squeegee key **Fig. 50-45**.
2. Loosen the lock nuts **Fig. 49-A** and turn the adjusting bushing **Fig. 49-B** to adjust the squeegee so that the ends of the sealing strips barely have contact with the ground.

#### Turning the adjusting bushing clockwise:

The distance of the sealing strip to the ground increases at the ends **Fig. 49**.

#### Turning the adjusting bushing counter-clockwise:

The distance of the sealing strip to the ground decreases at the ends **Fig. 50**.

3. Turn on the machine and check the suction pattern. When driving, the sealing strips must be turned over evenly everywhere (centre and outside).
4. Tighten the lock nuts.

### Height adjustment

The height adjustment (X) of the supporting rollers **Fig. 51-A** has been set to 7 mm in the factory. If striping still occurs despite optimum inclination adjustment, readjust the distance between the supporting rollers and the lower edge of the sealing strip.

Distance from floor (X)	Use
<7 mm	Very smooth floor surfaces, e.g. coated screed, PVC, linoleum
<b>7 mm</b>	<b>Standard setting</b>
>7 mm	Very uneven floor surfaces, e.g. poorly laid tiles (water does not drain off)

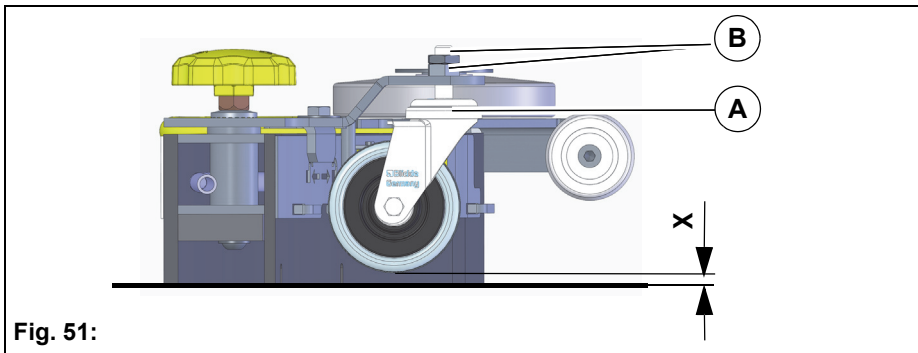

Fig. 51:

1. Place the machine on a level surface.
2. Lower the squeegee. The sealing strips must now be resting vertically onto the floor.
3. Loosen nuts **Fig. 51-B** and adjust distance between supporting roller and ground as per the table.
4. Tighten nuts.

## 5.8 Wiper

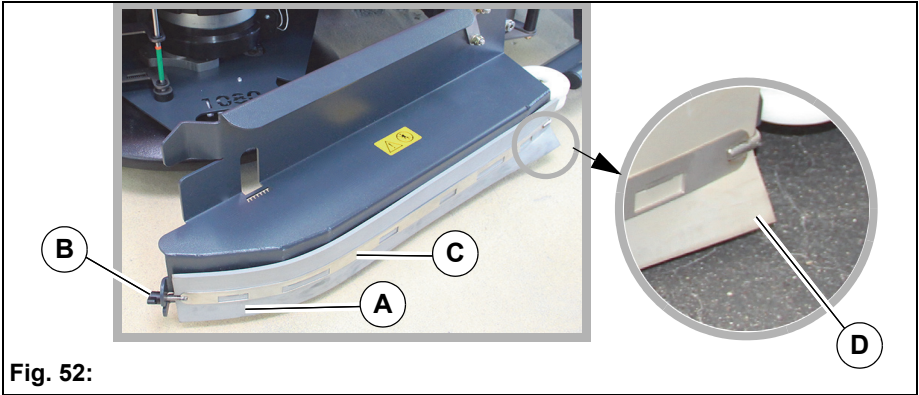

Fig. 52:

### 5.8.1 Changing the wiper rubber

Check the rubber of the wiper **Fig. 52-A** weekly for wear, turn or replace the rubber if necessary.

1. Loosen the wing nut **Fig. 52-B**.
2. Remove the clamping band **Fig. 52-C**. Turn the rubber of the wiper (can be used 4 times) or replace it.

Assembly is in reverse order.



#### Note

During installation, ensure that the corner of the wiper rubber is pointing outwards **Fig. 52-D** so that the wiper rubber folds over outwards during operation.

## 5.9 Pre-sweep suction unit (optional)

### 5.9.1 Emptying the dirt hopper

Check the fill level of the dirt hopper at regular intervals (max. load 20 kg) and empty if necessary.

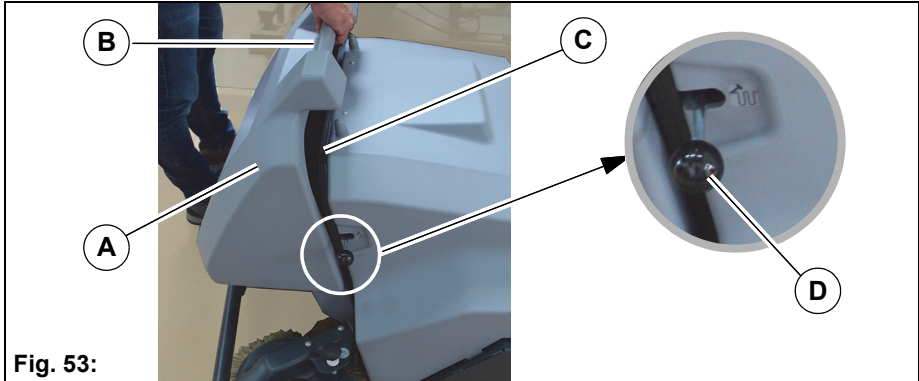

Fig. 53:

1. Turn off the machine.
2. Pull the dirt hopper **Fig. 53-A** upwards using the handle **Fig. 53-B** and dispose of the contents in an environmentally friendly way.
3. Reinsert the dirt hopper.

### 5.9.2 Dirt hopper seal

Inspect the dirt hopper seal **Fig. 53-C** weekly and replace if wear is present.

1. Turn off the machine.
2. Remove the dirt hopper.
3. Remove the damaged seal.
4. Press the new seal onto the edges.

### 5.9.3 Shaking the filter

Clean the filter **Fig. 54-B** several times per day using the shaking system **Fig. 53-D**.

To clean the filter, pull out the lever of the shaking system several times and slide back in again.

### 5.9.4 Cleaning the filter



#### Danger

Health hazard!  
Do not inhale the dust!  
Wear a suitable dust mask.

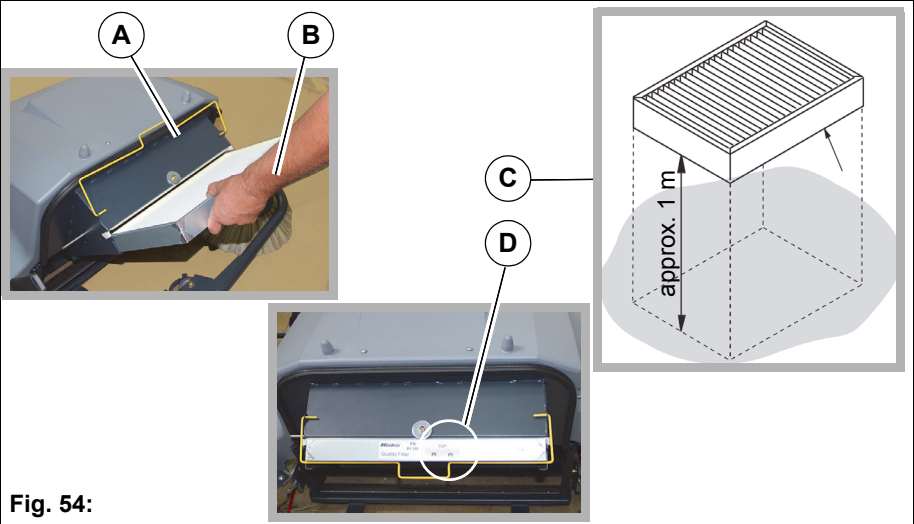

**Fig. 54:**

1. Switch off the machine and remove the dirt hopper.
2. Swivel the yellow handle **Fig. 54-A** upwards and pull the filter **Fig. 54-B** out of the frame.
3. Allow the filter to fall horizontally onto a smooth floor from a height of approx. 1 m.  
The dirty side must be facing the floor **Fig. 54-C**!
4. The filter is installed in the reverse order.



#### Attention

Ensure that the installation position is correct!  
Markings can be found on the frame of the filter.

### 5.9.5 Cleaning the cylindrical brush and the cylindrical brush compartment

Inspect the cylindrical brush **Fig. 55-A** and the cylindrical brush compartment for soiling daily and clean if necessary.

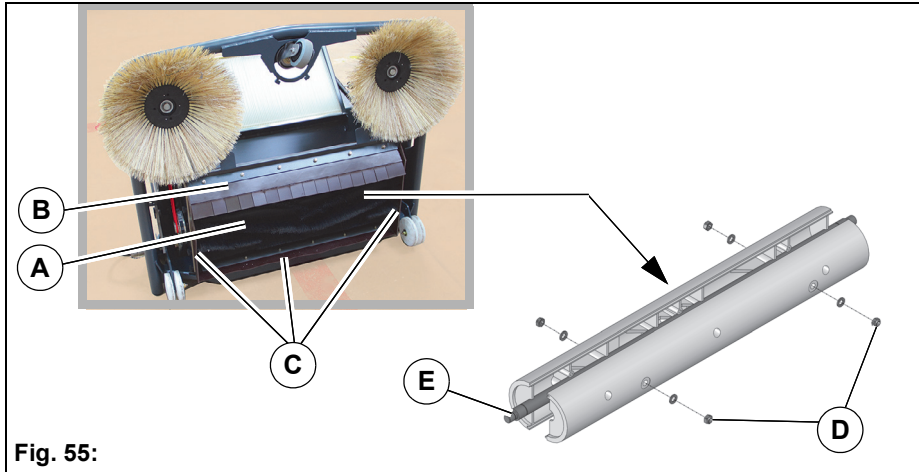

Fig. 55:

1. Disconnect the pre-sweep suction unit from the machine.
2. Remove the dirt hopper **Fig. 53-A**.
3. Tilt the pre-sweep suction unit backwards (see Fig.).
4. Remove rolled-up bands from the cylindrical brush.
5. Inspect the front apron **Fig. 55-B** and the sealing strips **Fig. 55-C** for soiling daily and clean if necessary.

### 5.9.6 Changing the cylindrical brush

Inspect the cylindrical brush once per week and replace if wear is present. Follow instructions 1 - 3 In chapter 5.9.5 *Cleaning the cylindrical brush and the cylindrical brush compartment*.

4. Loosen the nuts and washers **Fig. 55-D** and remove the first half shell.
5. Manually rotate the cylindrical brush shaft 180° by hand and remove the second half shell.
6. Attach the new half shells in the reverse order.
7. The sweeping level must be readjusted after replacing the cylindrical brush.

### 5.9.7 Adjusting the sweeping level

In the event of bristle wear and after replacing the cylindrical brush, the sweeping level **Fig. 55-A** must be readjusted.



#### Note

Mark the floor with chalk to check the sweeping level.

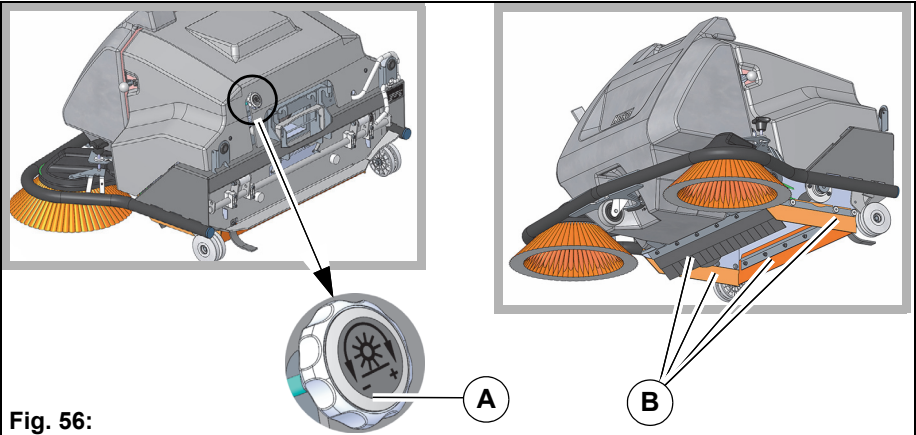

**Fig. 56:**

1. Switch off the machine using the key switch.
2. Rotate the adjustment dial **Fig. 56-A** until the cylindrical brush is touching the floor.
3. Switch on the machine and let the cylindrical brush rotate briefly while stationary.
4. If the setting is correct, a parallel-running sweeping level of approx. 45 +/- 10 mm must be marked on the ground.
5. If necessary, repeat the process until the setting is correct.

### 5.9.8 Replacing the sealing strips of the cylindrical brush compartment

The sealing strips must be in perfect condition for the pre-sweep suction unit to operate efficiently. Inspect the sealing strip of the cylindrical brush compartment **Fig. 56-B** for wear and check for damage at regular intervals.

Replace defective sealing strips as follows:

Follow instructions 1 - 3 In chapter 5.9.5 *Cleaning the cylindrical brush and the cylindrical brush compartment*.

4. Remove the mushroom-head screws, washers, nuts and terminal strip of the defective sealing strip.

5. Install the new sealing strip in the reverse order.

The lateral sealing strips are adjustable (elongated holes in the sealing strips). Adjustment dimension: approx. 1 mm from floor.

### 5.9.9 Changing the side brush

Inspect the side brushes once per week and replace if wear is present.

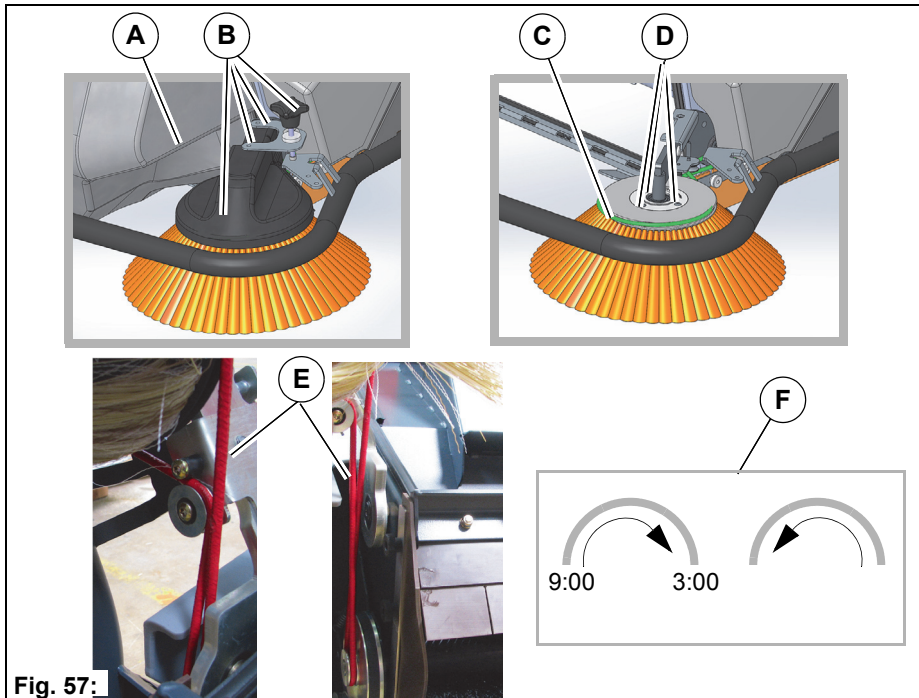

Fig. 57:

1. Switch off the machine and remove the dirt hopper **Fig. 57-A**.
2. Remove both M6x16 flanged button head bolts, the brush adjuster and the cover **Fig. 57-B**.
3. Remove the round belt from the side brush **Fig. 57-C**.
4. Loosen the three screws **Fig. 57-D** of the side brush and remove it.
5. Fit the new side brush in the reverse order. Pay attention to the run of the belt **Fig. 57-E**.

### 5.9.10 Adjusting the sweeping level

The sweeping level must be readjusted if the event of brush wear and after replacing the side brush.

1. Turn off the machine.
2. Rotate the adjusting wheel until half of the side brush is touching the floor. Compared to a clock, the sweeping level must be from approx. 9 o'clock to 3 o'clock on the floor **Fig. 57-F**.



## 6 Attachments/options

### 6.1 Spray suction tool

The spray suction tool **Fig. 58-A** is used for manually cleaning difficult-to-reach points.



#### Attention

- The spray suction tool is used to suck up dust. Only suck with the addition of water!
- Do not use the spray suction tool while driving!



#### Note

Before starting up for the first time, the provided adapter must be securely attached to the end of the hose **Fig. 58-B**.

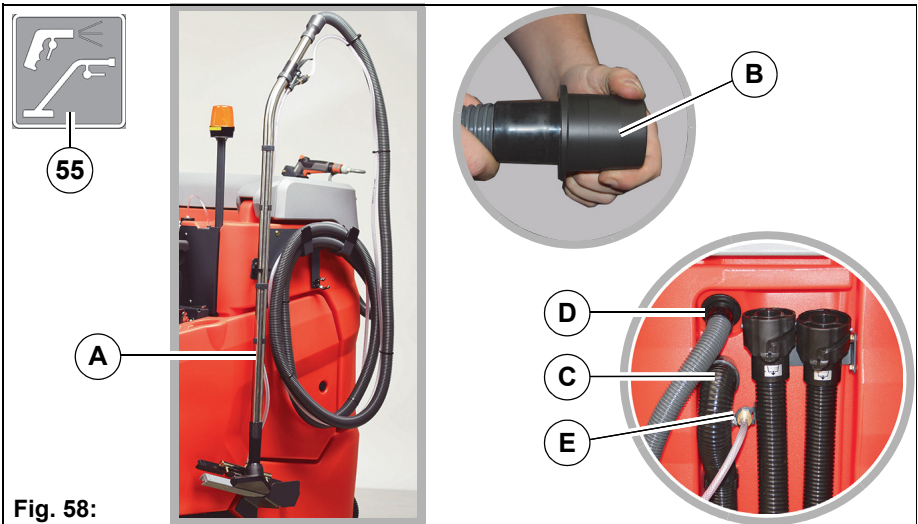

**Fig. 58:**

1. Reconnect the suction hose in the park position **Fig. 58-C**.
2. Insert the hose of the tool into the opening of the vacuum system **Fig. 58-D**.
3. Connect the hose to the water connection of the machine **Fig. 58-E**.
4. Use the *tool operation* button **Fig. 58-55** on the control panel to switch the tool on and off. The operator must not be sitting on the seat.  
Push the button twice: Spray suction tool ON  
Push the button again: Spray suction tool OFF

## 6.2 Manual suction tool:

The manual suction tool **Fig. 59-A** is used for manually cleaning difficult-to-reach points.



### Attention

- The manual suction tool is not used to suck up dust. Only suck up water!
- Do not use the spray suction tool while driving!

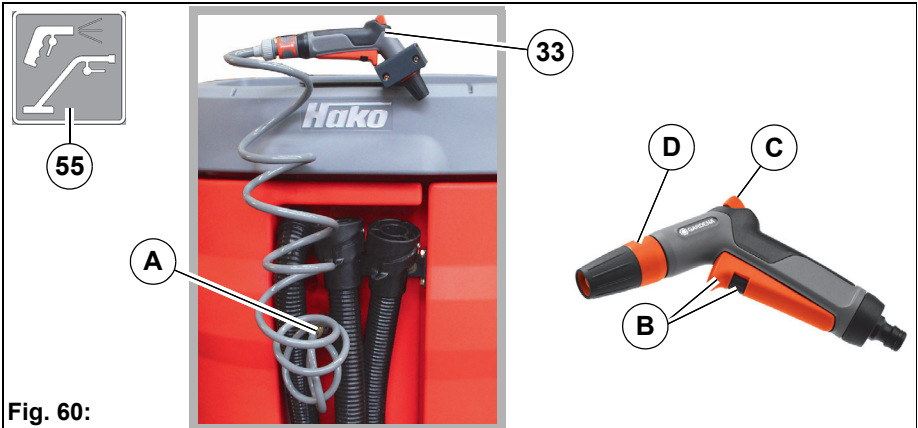

**Fig. 59:**

1. Reconnect the suction hose in the park position **Fig. 59-B**.
2. Insert the hose of the tool into the opening of the vacuum system **Fig. 59-C**.
3. Use the *tool operation* button **Fig. 59-55** on the control panel to switch the tool on and off. The operator must not be sitting on the seat.  
Push the button twice: Manual suction tool ON  
Push the button again: Manual suction tool OFF

### 6.3 Spray nozzle

The spray nozzle **Fig. 60-33** is used to flush the solution tank and waste water tank.



**Fig. 60:**

1. Connect the hose to the water connection of the machine **Fig. 60-A**.
2. Use the Tool operation button **Fig. 60-55** on the control panel to turn the water supply on and off. The operator must not be sitting on the seat.  
Push the button: Spray nozzle water supply ON  
Push the button again: Spray nozzle water supply OFF
3. Spray nozzle operation:
  - B** = operating handle for turning the water supply with locking mechanism on and off.
  - C** = adjusting lever for water dosing.
  - D** = setting the type of water jet.

## 6.4 Pre-sweep suction unit

The pre-sweep suction unit picks up dirt in the dry area in front of the scrubbing unit. The two side brushes brush the dirt directly into the path of the cylindrical brush. The cylindrical brush then sweeps the dirt forwards into the dirt hopper. The fine dust that is swirled up by the cylindrical brush is transported against the filter element by the suction fan.

### 6.4.1 Pre-sweep suction unit installation

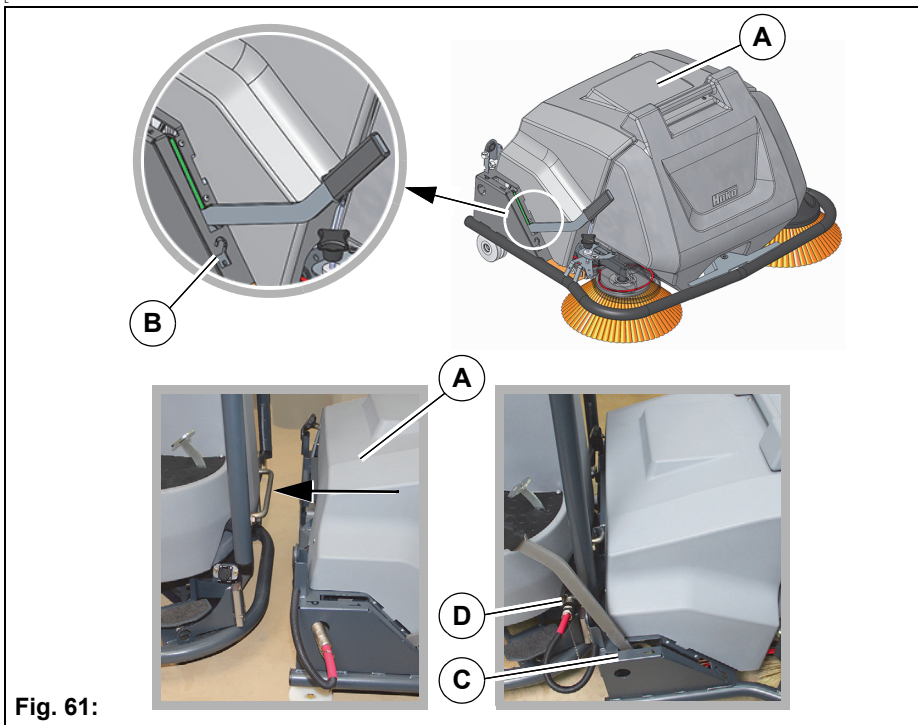
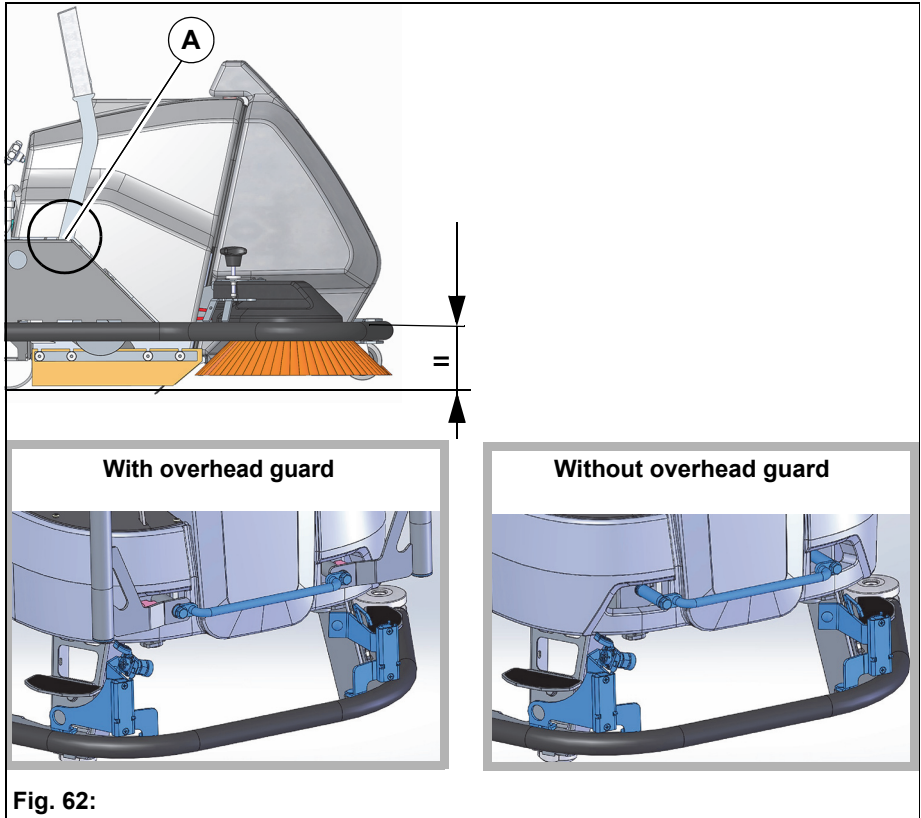

Fig. 61:

1. Slide the pre-sweep suction unit **Fig. 61-A** as far as the swivel bracket on the machine in a central position. The lever is in the change position **Fig. 61-B**.
2. Move lever to position *P* **Fig. 61-C**.
3. Insert the plug into the socket at the front right of the machine and secure with the knurled nut **Fig. 61-D**.

The pre-sweep suction unit is now attached to the machine.

## 6.4.2 Check and correct settings



**Fig. 62:**

If the pre-sweep suction unit is attached to the machine and the lever is in the sweeping position (Pos. 1) **Fig. 61-A**, the frame must be aligned parallel to the floor.

If this is not the case, the following steps must be taken:

1. Disconnect the pre-sweep suction unit.
2. Unscrew the swivel bracket **Fig. 61-B** from the machine. The tilt angle of the frame is determined by adding or removing the washers **Fig. 61-C**. The following applies: the more the washers are used, the more the frame will tilt downwards at the front.

### 6.4.3 Sweeping operation



#### Attention

- Do not use the pre-sweep suction unit unless the dirt hopper is attached!
- Sweeping up dust that is hazardous to health is not permitted!
- Ensure that there is sufficient ventilation when performing sweeping tasks in enclosed rooms!



56



A

B

Fig. 63:

1. Switch the machine on and press the *Pre-sweep suction unit* Fig. 63-56 button on the control panel.
2. Move the lever of the pre-sweep suction unit from pos. P to pos. 1 Fig. 63-A and set off.

### 6.4.4 Stop sweeping operation

1. Press the *Pre-sweep suction unit* Fig. 63-56 button on the control panel.
2. Move the lever of the pre-sweep unit from pos. 1 to pos. P Fig. 63-B.

### 6.4.5 After sweeping



#### Danger

- Risk of electric shock!  
Do not clean the electrical components using water!

#### Attention

- Make sure that the dust filter is not wet.
- Insert the dirt hopper before cleaning.
- Cleaning the machine with a high-pressure cleaner or steam jet is not permitted!

1. Drive to a suitable maintenance location.
2. Operate the shaking system.
3. Empty the dirt hopper.

4. Check the cylindrical brush compartment for contamination and remove if necessary.
5. Clean the pre-sweep suction unit if necessary.

#### 6.4.6 Parking the pre-sweep suction unit

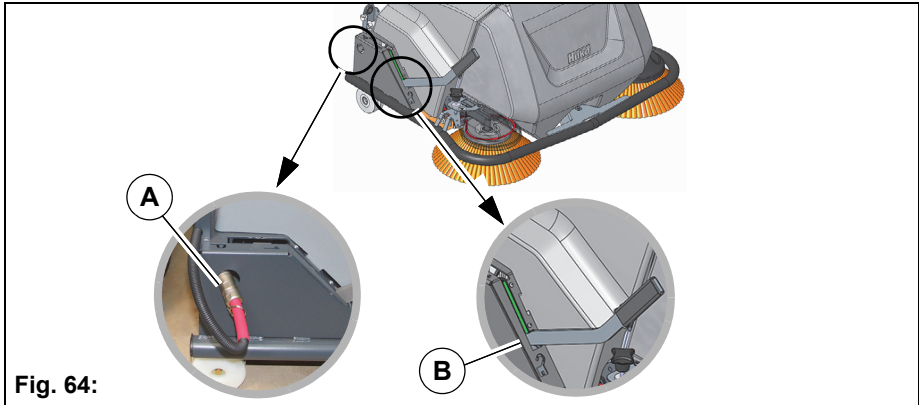

**Fig. 64:**

1. Unplug the plug at the machine side and plug into the retaining hole **Fig. 64-A**.
2. Move the lever to the change/parking position **Fig. 64-B**.
3. Park the pre-sweep suction unit on a level surface and in a dry, clean location.

#### 6.5 Overhead guard

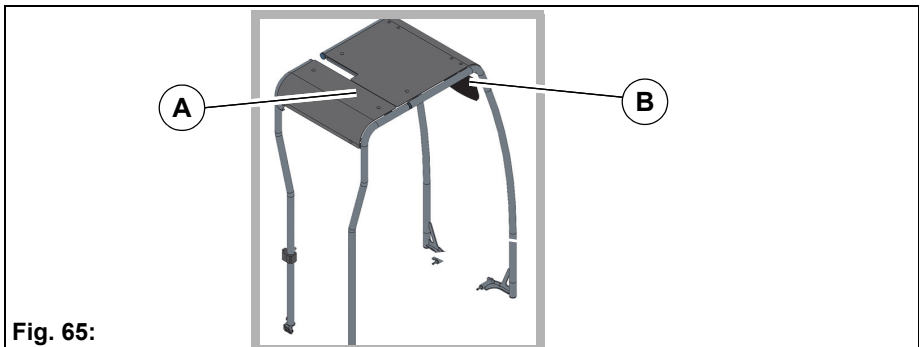

**Fig. 65:**

The overhead guard **Fig. 65-A** is used to protect the driver from falling parts in the high bay warehouse, for example.

An optional side mirror **Fig. 65-B** is available.

## 6.6 Blue Spot

The Blue Spot **Fig. 66-A** is a visual warning device. A blue spot projected onto the ground warns people and vehicles of approaching machines. In addition, a warning signal can be output, see page 37.



### Danger

Possible eye injury!

- Avoid looking directly at the light. Make sure in particular that children always follow this safety advice.
- Never adjust the set angle of the Blue Spot.

A



Fig. 66:



## **EC Declaration of Conformity**

**Hako GmbH**  
**Hamburger Str. 209-239**  
**23843 Bad Oldesloe, Germany**

declare in sole responsibility that the following products

**Scrubmaster B260 R model: 7182**  
**and**  
**Pre-sweep suction unit model: 7180.50**

to which this declaration relates correspond with the relevant basic safety and health requirements of EC Directive 2006/42/EC as well as the requirements according to 2014/30/EC and 2014/53/EC.

The following standard(s) and technical specifications was/were referred to for the correct implementation of the safety and health requirements named in the EC Directive:

**EN 60335-2-72**  
**EN 55012**  
**EN 61000-6-2**

Name of the authorised person who compiles the technical documents for Hako:

Ludger Lüttel

Bad Oldesloe, 02.05.2019



Ricardo Ruiz Porath  
Product line manager – cleaning technology

## Hako: environmentally friendly from the start

We want to leave a clean earth behind. Protecting resources, the environment and the climate therefore governs all our activities. Independent institutes have confirmed this.

## Everywhere and always in your vicinity

Our efficient distribution and service network guarantees short journeys and fast help.

## Purchasing, leasing, renting

We offer you a multitude of individual and attractive financing and procurement possibilities.

## We are here for you day and night

The Hako stand-by and spare parts express service guarantees the highest availability.



Cleanliness combined with safety  
Our machines meet the highest demands.



Blue Competence is an initiative of the VDMA ([www.vdma.org](http://www.vdma.org)). By using the trademark "Blue Competence", we commit ourselves to these twelve Sustainability Guidelines of the Mechanical Engineering Industry: [www.bluecompetence.net/about](http://www.bluecompetence.net/about)

Hako GmbH  
Head Office  
Hamburger Str. 209-239  
23843 Bad Oldesloe  
Germany  
Tel. +49 (0) 4531-806 0  
[info@hako.com](mailto:info@hako.com)  
[www.hako.com](http://www.hako.com)